



GENERAL CATALOGUE

WATER TREATMENT SYSTEMS





WATER
TREATMENT
SYSTEMS



SIMPLE AS WATER

Water is a vital element. We are connected to it by a covenant of respect and pure gratitude. For over 40 years we have been working to make the human-water relationship more harmonious, safe and natural, drawing from a single source of inspiration.

The simplicity.

Flexibility, with three fundamental principles

Since 1982, we have been designing and producing reliable, cutting-edge instruments for water treatment and chemical dosage. In a world that changes so fast, flexibility and innovation are fundamental to us.

As a company, we are open to change, because we are rooted in three fundamental principles: constant research, extreme precision, healthy relationships.

CONSTANT RESEARCH

Being at the cutting edge means constant study. Our R&D and design departments are where our heart beats.

Extremely high-profile engineers and technicians are committed to developing software and designing hardware, but also to studying and evaluating hydraulic and mechanical components.

Just like water, we have branched out over time, spreading out into wide-ranging areas.

- Industrial water treatment
- Purification plants
- Treatment of water used in industrial processes
- Chemical-physical purification processes
- Bacteriological purification systems
- Sewage irrigation plants
- Chemical industry
- Food processing Industry
- Cooling towers
- Refineries
- Wellness centres
- Swimming pools
- Car washes

EXTREME PRECISION

Our second fundamental principle is complete control of our production line.

We are entirely responsible for every stage of the process, from invention to delivery. Our products undergo up to 10 quality checks and are tested four times before reaching the customer.

The quality management system of our production process is **ISO 9001** certified and has customer satisfaction as its ultimate goal, as well as continuous improvement of company performance.

Customers satisfaction comes hand-in-hand with ensuring safety for them, their operators and final users.

Our dosing pumps and controllers are **UL** certified to guarantee full compliance with general requirements for safety of use, while **NSF** certifications guarantee that our pumps do not release hazardous pollutants into the water and therefore are fully safe for use in contact with drinking water, for example in the food production industry, or at recreational facilities like swimming pools and spas.

HEALTHY RELATIONSHIPS

Extremely high performance, top quality and high technology are our greatest assets. But there is more.

Every day, we safeguard something equally important: human capital.

Our co-workers are the best professionals on the market; the most expert and competent people.

For this reason our organizational model is designed to manage their safety and health in an organic and systematic way, respecting the international standard **ISO 45001**.

At the moment our company numbers nearly 200 employees, 35% of these are women. Statistically, this is a highly respectable percentage in a technical sector like ours. It is a number that is destined to grow.



The difference between consultant and supplier

Over the years, we have learnt to be good listeners, which is fundamental to an understanding of customers' real needs. This delicate task is handled by our Business Unit, which is entirely made up of technicians.

Their in-depth knowledge of every step of the production process makes it possible for them to offer focussed consulting, both for the choice and the personalisation of products.

We can offer a high level of customisation, which ranges from branding to hardware and software modifications made to standard models.

A BACK OFFICE THAT IS ALWAYS UP FRONT

It is one of the feathers in our cap: a helpful and competent back office. Every day, their important contribution ensures that every aspect of our supply process is impeccable. This excellent care and attention contributes to the fact that the number of customers who choose to leave us is close to zero.

QUALITY FROM THE OUTSET TO AFTER-SALES

For us, closing a deal does not mean the end of a relationship. We remain at our customers' disposal to make sure that, over time, our products are working properly. We are ready to respond to any request in real time, even outside office hours.

COMPETENCE THAT SETS A PRECEDENT

As leaders in our sector, we realise that we have a great responsibility: preparing specialists and customers so that they can use the products we produce in the best possible way.

That is why we created the Emec Training Program: a series of training courses dealing with installation and maintenance in both private and company contexts.

Our training and refresher courses are run at our expense; and that includes participant's logistics costs. So you do not have to pay, but you earn in terms of competence.





A world of care and attention

Water is the vital element on which our business is based. The least we can do to respect this inestimable resource is treat the environment in the best possible way. It is not just about abiding by laws, it is about respect for our ethics.

LESS IMPACT, MORE SUSTAINABILITY

We think of sustainability as an endless path: each responsible step we take further reduces our company's environmental footprint.

To this end, we have adopted an Environmental Management System compliant with the international standard **ISO 14001**. This makes it possible to reduce atmospheric and acoustic emissions well below the prescribed limits; to rationalise consumption of water, electricity and gas; and to reduce the production of waste and the contamination of the land.

Sustainability also means giving waste material a second life: we recycle or reclaim 93% of circuit boards, paper and plastic; as well as shreds or chips of iron, aluminium, copper, bronze, brass and wood. In addition, we are equipped with an extractor that separates water from oil during the machine cleaning process, so that it can be reused in the production process.

MAXIMUM EFFICIENCY. STARTING WITH ENERGY

We have opted for renewable energy sources, state-of-the-art boilers, and intelligent air conditioning. This has made it possible for us to drastically reduce our consumption of gas and electricity. The only energy we do not want to save is the one we put into our work.

FROM GOOD INTENTIONS TO BEST PRACTICES

Everything we do to improve sustainability is shared with our employees, collaborators and partners through information and training activities. Every update is included in our Integrated System Manual: a tool that we ask everyone to respect in order to ensure that good intentions correspond to the day to day practices at work.

EXCLUSIVE DISTRIBUTORS FOR EXCLUSIVE QUALITY

Becoming an exclusive Emec dealer in your country is an excellent opportunity for a variety of reasons:

- The excellent value for money of our references;
- Our company is extremely solid with a long-standing management structure;
- Guaranteed, qualified support to manage processes and solve technical and administrative problems;
- An in-house shipping department that can guarantee lead times (from order to shipment) to any country in the world;
- Access to training and refresher courses;
- Assistance is available directly online and can be accessed at any time. through the Reserved Area on **emecpumps.com**;
- Precious support for branding and communication.

NOTHING IS MORE SIMPLE THAN COMPLEXITY

The numbers speak for themselves. We are an extremely prolific company, with high-level technical know-how. We manage articulate and complex processes with increasingly sophisticated standards of innovation.

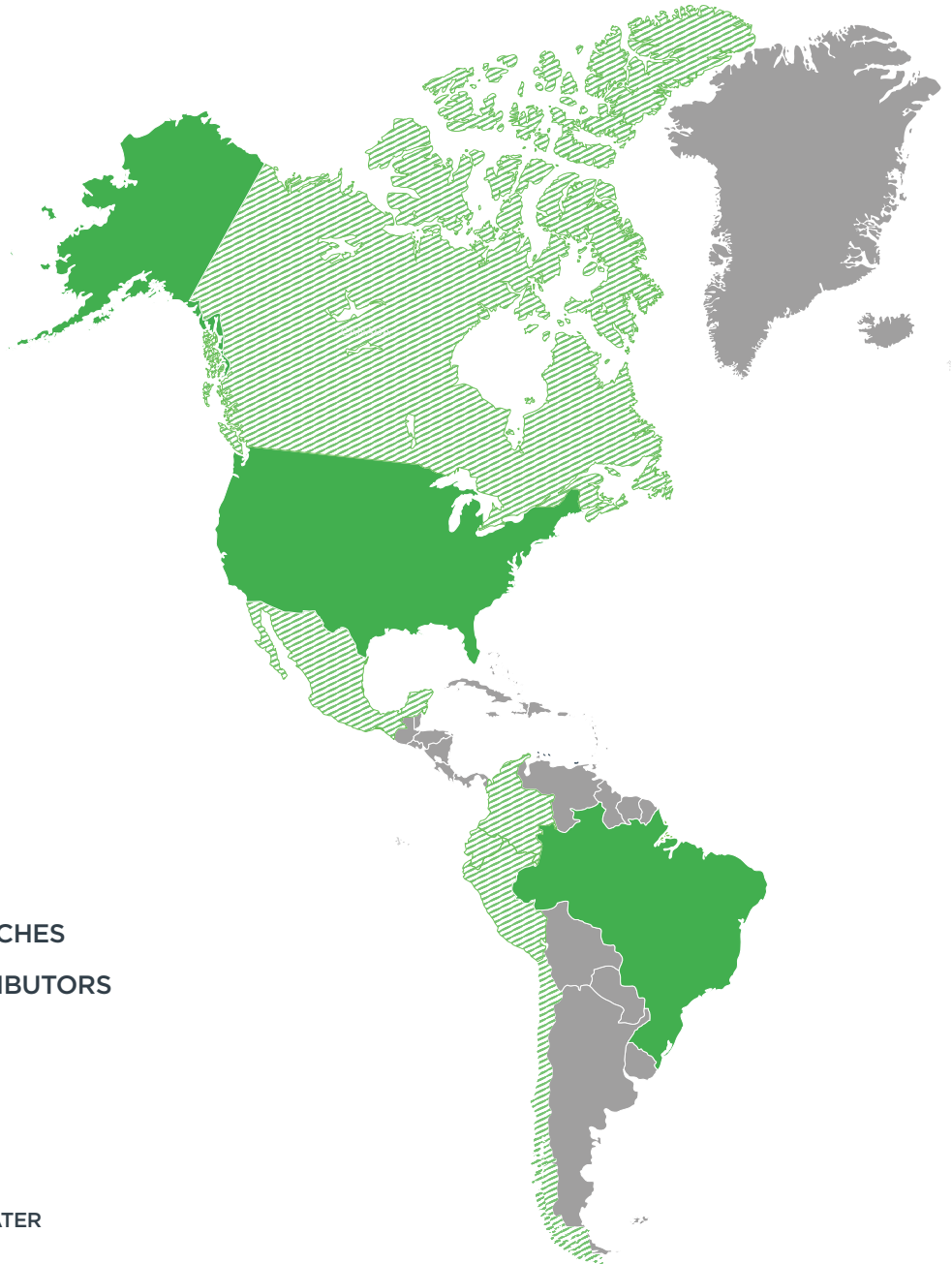

-  BRANCHES
-  DISTRIBUTORS

EMEC SIMPLE AS WATER

- 40+ years of excellence
- 250+ employees
- 88 countries
- 10 branches
- 10+ sectors
- 120.000 dosing pumps/year
- 15.000 controllers/year
- 26.000 probes & sensors/year
- 8.000 dosing station/year
- 85.000 accessories



100% MADE IN ITALY
All our products are 100%
Made in Italy



WARRANTY
5 years warranty for our dosing
pumps and controllers.
Terms and conditions apply



Emec Worldwide

And all with the same objective: *to make the lives of companies and professionals increasingly simple.*

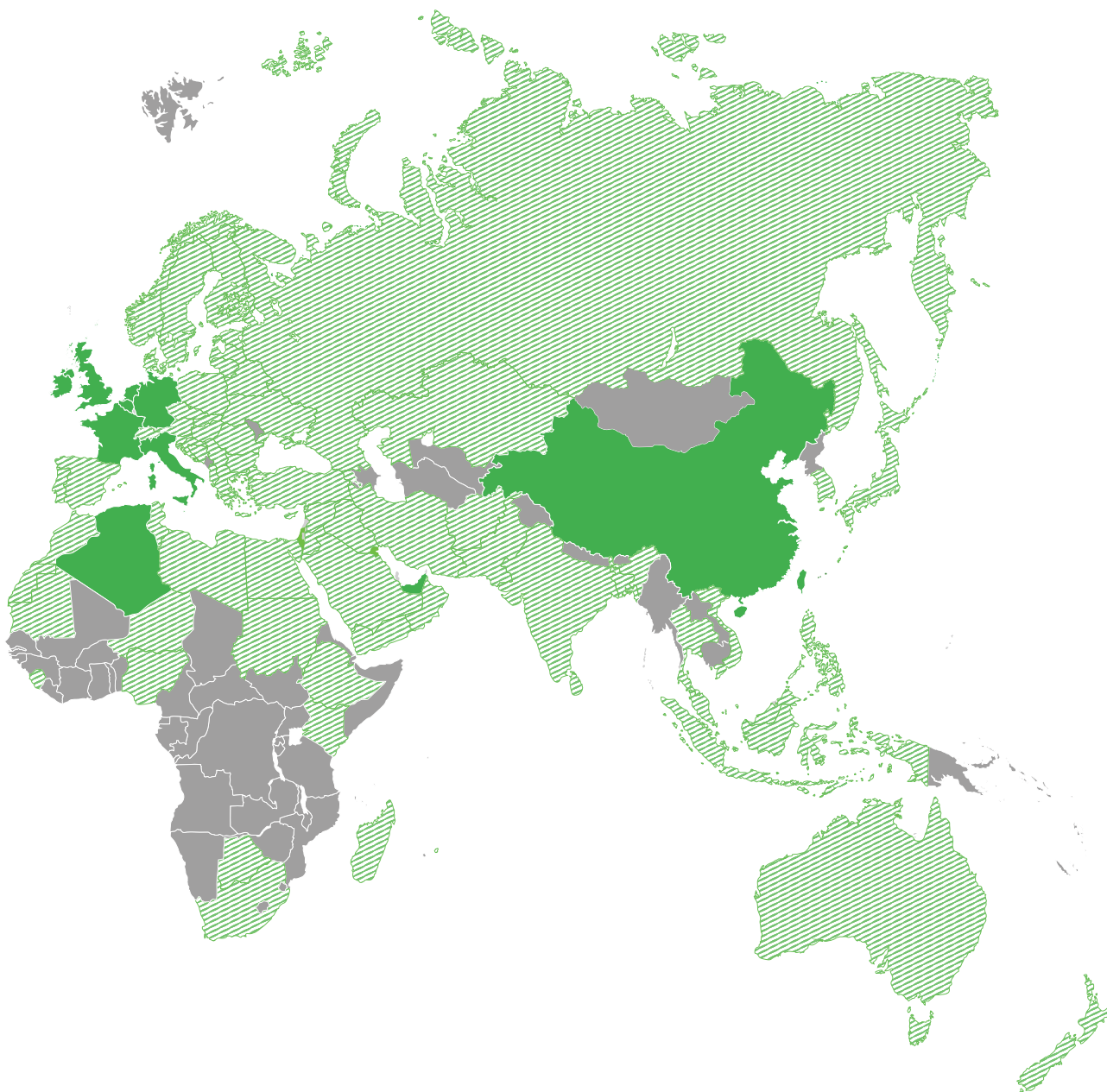

OUR CERTIFICATIONS



OUR SOCIAL CHANNELS



INDEX

Dosing Pumps

STEPPER DOSING PUMPS	10/17
<i>Stepper Motor Dosing Pumps: Prisma, WN, WT, Velon</i>	
SOLENOID-DRIVEN DOSING PUMPS	18/21
<i>Solenoid-driven dosing pumps AMS, K, T, V series</i>	
SOLENOID-DRIVEN DOSING PUMPS WITH CONTROLLER	22/24
<i>Solenoid-driven dosing pumps WD, WT series</i>	
COMPRESSED AIR DOSING PUMPS	25/25
<i>Solenoid-driven dosing pumps RAC series</i>	
MULTIFUNCTION MOTOR-DRIVEN DOSING PUMPS	26/27
<i>Multifunctional motor-driven dosing pumps PRIUS D MF and P MF series</i>	
MOTOR-DRIVEN DOSING PUMPS	28/29
<i>Motor-driven dosing pumps PRIUS D and P series</i>	
ACCESSORIES FOR DOSING PUMPS	30/31
<i>Tanks, mixers, lances, valves, sensors, water meters</i>	
PULSE OUTPUT METERS	32/33
<i>Pulse output meters and meters pulses per litre table</i>	
MODEM AND EXTERNAL MODULES	34/34
<i>For LD, MTOWER, WD and CENTURIO controller series</i>	

Controllers

CENTURIO PRO/TOWER/POOL	36/37
<i>Multi-parameter digital controllers</i>	
LD MULTICHANNEL/ LD MULTICHANNEL PRO	37/37
<i>2-channel controllers</i>	
LDS/LDS PLUS	38/39
<i>1-channel controllers</i>	
MTOWER PLUS/2 CH/1 CH	40/40
<i>Controllers for cooling towers with up to 3 channels</i>	
RACK CONTROLLERS	41/41
<i>Rack-mount controllers JA PRO, J DIGITAL and DIN DIGITAL series</i>	
MEASUREMENT SYSTEMS	42/43
<i>Probes Chlorine, pH, ORP, Dissolved Oxygen, Turbidity, Tracers ...</i>	
ACCESSORIES FOR MEASURING SYSTEMS	44/44
<i>Probe Holders, Filters, Buffer Solutions</i>	

Pre-configured solutions, skids, cabinets and dosing stations

LOTUS DISINFECTION SYSTEMS <i>All-in-one chlorine dioxide disinfection systems</i>	46/57
POOLBRAVO <i>All-in-one system for swimming pool installations</i>	58/59
PRE-CONFIGURED SOLUTIONS FOR POOLS AND SPAS <i>Control and dosing systems for pools, spas and water treatment</i>	60/61
PRE-CONFIGURED SOLUTIONS FOR COOLING TOWERS <i>Control and dosing systems for for cooling towers</i>	62/63
PRE-CONFIGURED SKID SOLUTIONS <i>Multi-parameter dosing and control systems Skid</i>	64/65
REMOTE MONITORING AND CONTROL SYSTEMS <i>Nimbus, My Emec App</i>	66/71

PRISMA Series

Stepper motor dosing pumps



DIGITAL SERVICES



MAX FLOW RATE

80 l/h

MAX PRESSURE

25 bar

POWER SUPPLY

12-24 VDC

24 VAC

100-240 VAC

VENTING

Manual

FEATURES

- Pump head available in PVDF, PP, SS and PMMA
- Accessories available in PVDF and PP
- Stepper motor
- Multifunctional software
- High-strength PTFE diaphragm
- Horizontal mounting
- RGB backlit LCD display

STEPPER MOTOR

SLOW MODE TURNDOWN RATIO 1:4800

MULTI-COLOUR DISPLAY MULTIFUNCTION

WORKING MODES

CONSTANT MODBUS NIMBUS

CONSTANT WITH EXTERNAL INPUT PPM

% mA PAUSE-WORK WEEKLY TIMER

MLQ CC/PULSE VOLT

BATCH EXTERNAL/MANUAL

PUMP HEADS



PVDF



PP



SS AISI316L



PMMA

ACCESSORIES



Foot filter with level probe



Injection valve 1/2" or 3/4"



PRISMA stepper motor-driven dosing pump has been designed by EMEC to be the best solution for offering high-accuracy metering and extreme reliability.

Thanks to the new stepper motor and to the Multifunction software, **PRISMA** dosing pumps offer complete control over dosing speeds and working modes as well as great flexibility, meeting even extremely complex application needs.

INFO COLOR SCREEN

REAL-TIME FLOW

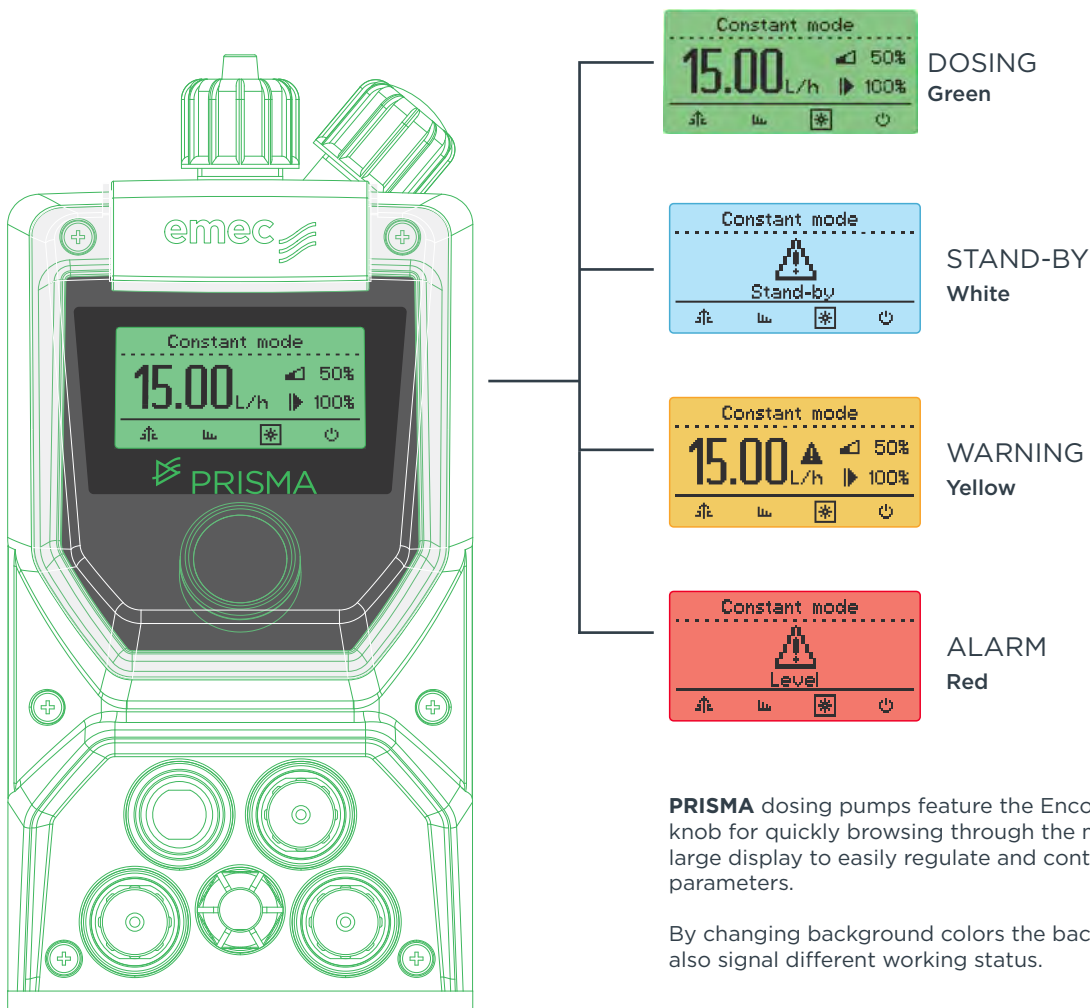

PRISMA dosing pumps feature the Encoder control knob for quickly browsing through the menus and a large display to easily regulate and control the working parameters.

By changing background colors the backlight display can also signal different working status.

TURNDOWN

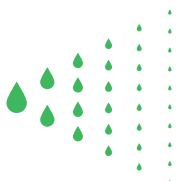

PRISMA stepper motor-driven pumps give you the most accurate control over the stroke speed, providing an outstanding turndown ratio of up to **4800:1**.

It means **PRISMA** can split up the dosing process into a maximum of **4800 steps** in order to offer the most homogeneous and precise distribution of the product to dose according to the required application.

SLOW MODE



Extreme versatility of **PRISMA** dosing pumps is also due to **Slow Mode** function.

With Slow Mode enabled you can reduce the suction speed from **100** to **30%** of the normal speed, making easier and more reliable the priming and the dosing even when you have to work with particularly viscous liquids.

WNPHXX Series

Stepper motor dosing pumps



WIFI



DIGITAL SERVICES



APP MY EMEC



ONLINE STATS



CUSTOMIZABLE



MAX FLOW RATE

12 l/h

MAX PRESSURE

2 bar

POWER SUPPLY

240 VAC

100-240 VAC

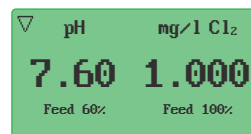

DOSING
Green

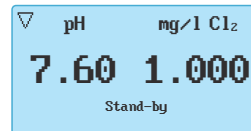

STAND-BY
White

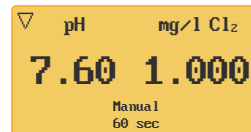

WARNING
Yellow

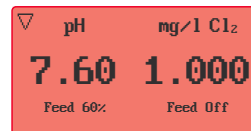

ALARM
Red

FEATURES

- No. 2 high-precision stepper motors
- Precision through peristaltic dosing
- Great flexibility of use (1 m³ - 250 m³)
- Low maintenance requirements (longlasting biocompatible peristaltic hose)
- Scheduled maintenance alerts
- Advanced operator safety (inverters and low-permeability materials)
- New automatic dosage adjustment system
- Built-in Wi-Fi connectivity
- Remote control via NIMBUS/ My EMEC App

BASIC MODEL ACCESSORIES

- 2 PVDF injection valves (0.3 bar)
- 2 PVDF foot strainers with PVDF level probes
- 8 meters of suction hose (flexible PVC)
- 2 long-lasting biocompatible hoses 4.8x1.6 (standard equipment)
- 2 long-lasting biocompatible hoses 1.6x1.6 (standard equipment)



PERFORMANCE

LONG-LIFE BIOCOMPATIBLE HOSE

Hose	Pressure		Flow Rate		RPM range
	bar	PSI	l/hr	gal/hr	rpm
Ø 1.6x1.6	2	36.2	0.018 - 1.8	0.0047 - 0.47	1 - 100
Ø 4.8x1.6	2	36.2	0.12 - 12	0.0317 - 3.17	1 - 100

Hose life comparison

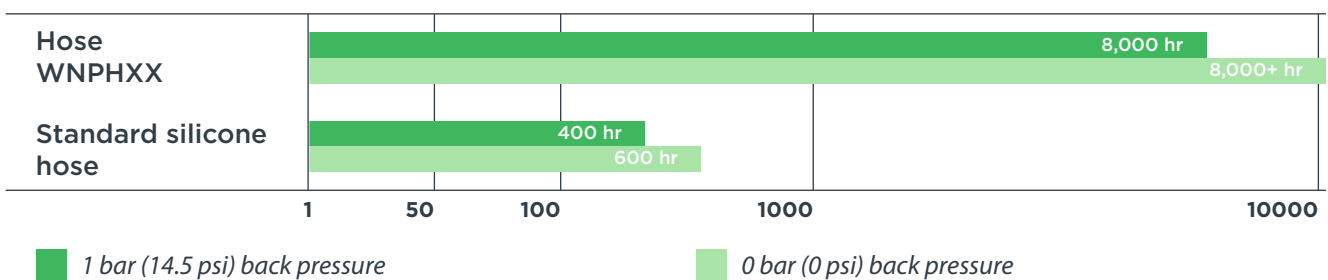

Permeability coefficient comparison (x10⁻¹¹)

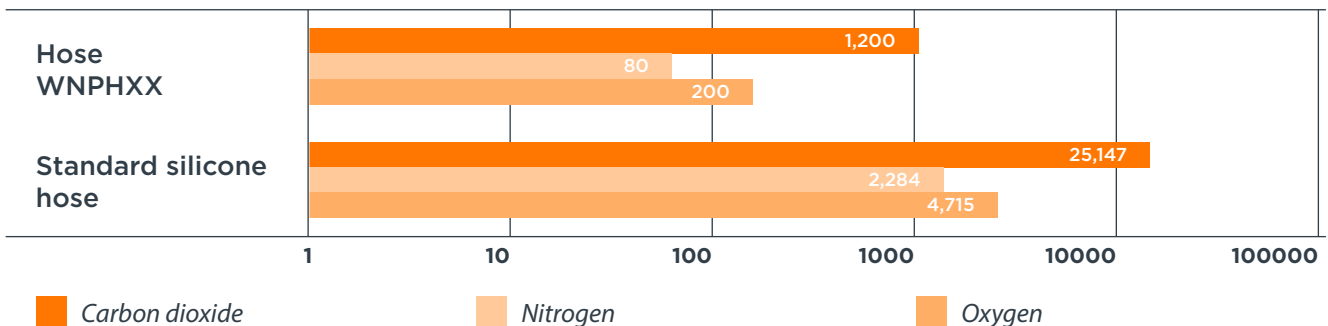

CHANNELS

UP TO TWO CHANNELS (+ TEMPERATURE)

- pH
- REDOX
- CLOSED AMPEROMETRIC CELLS
- OPEN AMPEROMETRIC CELLS (CHLORINE)
- CONDUCTIVITY
- TURBIDITY

CLOSED AMPEROMETRIC CELLS

- FREE CHLORINE
- TOTAL CHLORINE
- BROMINE

WT PER Series

Peristaltic dosing pumps with stepper motor



WiFi



DIGITAL SERVICES



APP MY EMEC



ONLINE STATS



CUSTOMIZABLE

MAX FLOW RATE

3 l/h

MAX PRESSURE

2 bar

POWER SUPPLY

100-240 VAC

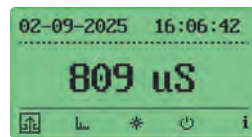

DOSING
Green

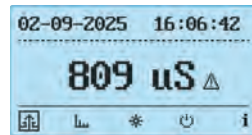

STAND-BY
White

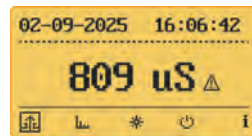

WARNING
Yellow



ALARM
Red

FEATURES

- No. 2 high-precision stepper motors
- High precision through peristaltic dosing
- Low maintenance requirements (long-life, biocompatible peristaltic tubing)
- LCD display with backlighting that adapts to device operation
- Encoder knob for instrument control
- PC+ABS box
- Flow control input
- Conductivity reading
 - 0/3 mS - 0/30 mS (ECDINDPT)
 - 0/10 mS (ECDSINDPT)
 - 0/10 mS (ECDCPT)
- Alarms: level, no flow
- Configurable digital inputs (N.O. / N.C.)
- Delayed start of dosing
- Permanent data storage with system log viewable on display
- Bluetooth LE / 2.4Ghz WiFi connection for APP and Remote Control
- Upgradable firmware (via OTA)
- Installation class II (IEC/EN 61010-1)
- Pollution level 2 (IEC/EN 61010-1 and IEC 60664-1)
- IP 65 protection (IEC/EN 60529)
- Manual or automatic bleed
- Built-in MODBUS
- Vertical installation
- Remote control via NIMBUS / My EMEC App

ACCESSORIES

- 2 long-life biocompatible hoses, 4.8 × 1.6 mm (standard supply)
- 2 long-life biocompatible hoses, 1,6x1,6 (included accessories)



PERFORMANCE

Hose	Pressure		Flow Rate		RPM range
	bar	psi	l/h	gal/h	rpm
Ø 1,6x1,6	2	29,0	0,018 - 0,45	0,0047 - 0,1175	1 - 25
Ø 4,8x1,6	2	29,0	0,12 - 3	0,0317 - 0,7925	1 - 25

LONG-LIFE BIOCOMPATIBLE TUBING

Hose life comparison

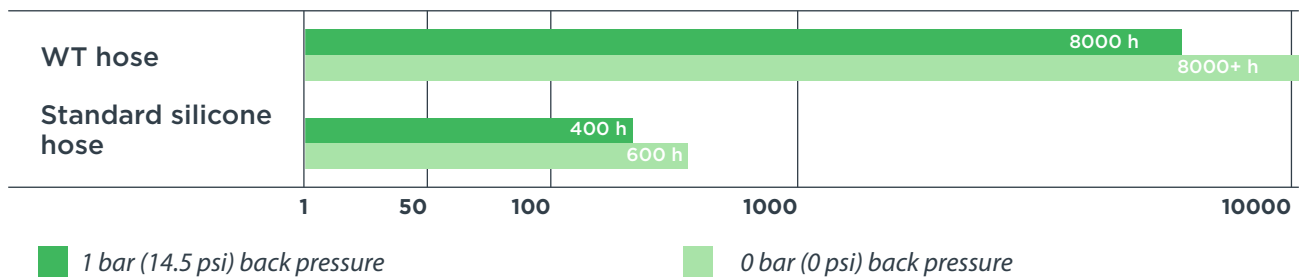

Permeability coefficient comparison ($\times 10^{-11}$)

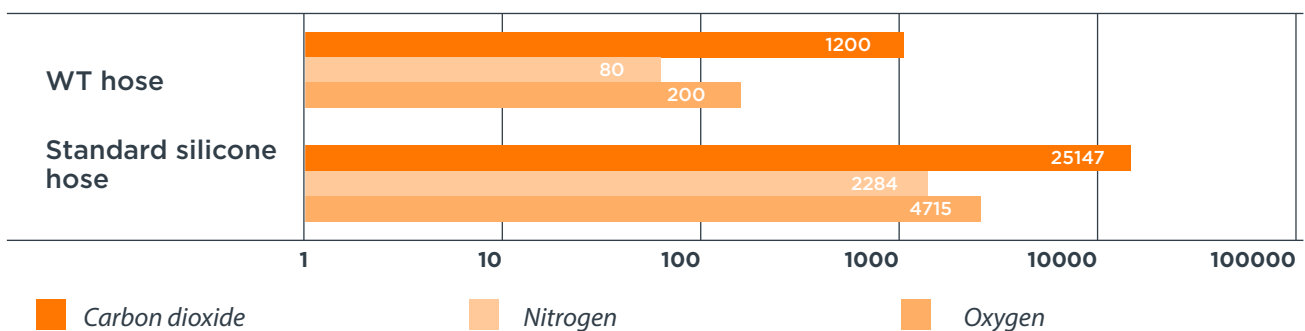

INPUTS

- CONDUCTIVITY PROBE
- INLET WATER METER
- LEVEL 1 AND LEVEL 2
- FLOW SENSOR
- STANDBY MODE

OUTPUTS

- ALARM (VOLTAGE-FREE RELAY CONTACT)
- MODBUS RTU PORT
- PUMP 1 AND PUMP 2
- BLEED (WATER DISCHARGE)

VELON Series

Peristaltic dosing pumps with stepper motor



WIFI



DIGITAL SERVICES



APP MY EMEC



ONLINE STATS



CUSTOMIZABLE



MAX FLOW RATE

12 l/h

MAX PRESSURE

2 bar

POWER SUPPLY

12 | 24 VDC

24 VAC

100-240 VAC

VELON is a state-of-the-art compact peristaltic dosing pump, equipped with a high-precision, electronically-controlled multifunction stepper motor that guarantees constant and regular chemical product dosing, even in demanding working conditions and with load variations. Designed to offer a complete, easy-to-use solution in all installation contexts that require precise, reliable, quiet and safe operation.

ACCESSORIES

- 1 PVDF injection valve (0.3 bar)
- 1 PVDF foot filter with level probe
- 4 m suction tubing (flexible PVC)
- 1 long-life biocompatible tubing, 4.8 x 1.6 mm (standard supply)
- 1 long-life biocompatible tubing, 1.6 x 1.6 mm (included accessory)

FEATURES COMMON TO THE ENTIRE SERIES

Microprocessor	Pressure (bar - psi)	RPM Range (rpm)	Protection	Power Supply	Installation Class
Next-Generation, High-Performance	2 (29)	da 1 a 100	IP65	24 100-240 VAC, 12VDC, 24VDC	II
Flow Rate Range (l/h - gal/h) (Ø1,6x1,6)	Flow Rate Range (l/h - gal/h) (Ø4,8x1,6)	Operating Temperature	Additive Temperature	Manufacturing Materials	Remote Control
0,018 - 1,8 l/h 0,0047 - 0,47 gal/h	0,12 - 12 l/h 0,0317 - 3,17 gal/h	10 - 45 °C 55 - 113 °F	0 - 50 °C 32 - 122 °F	PC/ABS, PVDF, POM, TPV	Web (NIMBUS) e App (MyEmec)



AVAILABLE VERSIONS



SPECIFIC MODEL FEATURES

	Velon MF	Velon PO	Velon CL	Velon PM
DESCRIPTION	Multifunction pump with extensive dosing modes and digital management, including remote control	Versatile pump with proportional adjustment and remote control	Essential, practical pump for constant dosing with manual adjustment via potentiometer	Pump with MODBUS RTU integration, ideal for automated systems
INTER./CONT.	Backlit RGB LCD display, encoder, remote management via app/web	Backlit LCD display, encoder, remote management via app/web	Front potentiometer, LED, ON/OFF button	MODBUS RTU, LED, tasto ON/OFF
WORKING MODE	Constant, CC/Pulse, PPM, %, MLQ, Batch, Volt, mA, Pulse, Weekly Program, Ext Constant	Proportional, Autodosing pH and/or Redox	Constant	External Control
MAINTENANCE	Scheduled maintenance via activity meters	Scheduled maintenance via activity meters	Scheduled maintenance via activity meters	Scheduled maintenance via activity meters
INPUT	MODBUS RTU, Multi-function, Level	MODBUS RTU, Standby, Level, Serial Probe	Level	MODBUS RTU, Level
OUTPUT	Alarm (optional)	Allarm (optional)	Allarm (optional)	Allarm (optional)
CONNECTIVITY	Wi-Fi & Bluetooth	Wi-Fi & Bluetooth	-	-
FW UPDATE	OTA	OTA	-	-

AMS Series

Solenoid-driven dosing pumps

FEATURES

- Electronic flow rate adjustment
- Mechanical adjustment of single injection volume (from 100% to 0%)
- Manual or automatic venting
- High-strength PTFE diaphragm
- Horizontal mounting
- Pump head in PVDF, PP, SS, PMMA
- Accessories in PVDF, PP

MAX FLOW RATE

60 l/h

MAX PRESSURE

25 bar

POWER SUPPLY

12 | 24 VDC

24 VAC

115 VAC

230 VAC

Compressed Air

VENTING

Manual

Self



DIGITAL

AMS MF | PH | RH

AMS MF multifunction

AMS PH built-in pH-meter (reading & adjustment)

AMS RH built-in ORP-meter (reading & adjustment)



ANALOG

AMS PLUS | CL PLUS | CO PLUS

AMS PLUS costante / costante 1-10
 moltiplicatore 1-10
 divisore 1-10 / 1-100 / 1-1000
 segnale in mA

AMS CL PLUS costante con controllo di livello e divisore 1/10

AMS CO PLUS costante con divisore 1/10

PUMP HEADS

Also available with configuration:

- Manual venting
- Compressed air

- Self venting
- Viscous liquids

- Low-viscosity liquids



PVDF



PP



SS AISI316L



PMMA



LPV



P

ACCESSORIES



Foot filter with level probe



Injection valve 1/2" or 3/4"



K Series

Solenoid-driven dosing pumps

FEATURES

- Electronic flow rate adjustment
- Mechanical adjustment of single injection volume (from 100% to 0%)
- Manual or automatic venting
- High-strength PTFE diaphragm
- Horizontal mounting
- Pump head in PVDF, PP, SS, PMMA
- Accessories in PVDF, PP

MAX FLOW RATE

18 l/h

MAX PRESSURE

20 bar

POWER SUPPLY

12-24 VDC
 24 | 115 | 230 VAC
 100 | 240 VAC

VENTING

Manual
 Self



DIGITAL

KMS DC | MF | PH | RH | CL

- KMS DC** constant
- KMS MF** multifunction + weekly timer
- KMS PH** built-in pH-meter (reading & adjustment)
- KMS RH** built-in ORP-meter (reading & adjustment)
- KMS CL** built-in chlorinometer (reading & adjustment)



ANALOG

K PLUS | CL PLUS | CO PLUS

- K PLUS** constant / constant 1-10 multiplier 1-10 divider 1-10 / 1-100 / 1-1000 mA signal
- K CL PLUS** constant with level control and 1/10 divider
- K CO PLUS** constant with 1/10 divider

PUMP HEADS

Also available with configuration:

- Manual venting
- Self venting
- Low-viscosity liquids



PVDF



PP



SS AISI316L



PMMA



LPV

ACCESSORIES



Foot filter with level probe



Injection valve 1/2"

T Series

Solenoid-driven dosing pumps

FEATURES

- Electronic flow rate adjustment
- Manual or automatic venting
- High resistance diaphragm
- Wall mounting
- Pump head in PVDF, PP, SS, PMMA
- Accessories in PVDF, PP

MAX FLOW RATE

100 l/h

MAX PRESSURE

20 bar

POWER SUPPLY

12 | 24 VDC

24 VAC

115 VAC

230 VAC

VENTING

Manual

Self



DIGITAL

TMS DC | MF | PH | RH

TMS DC constant

TMS MF multifunction + weekly timer

TMS PH built-in pH-meter (reading & adjustment)

TMS RH built-in ORP-meter (reading & adjustment)



ANALOG

T CL | CO

TCL constant with level control

TCO constant

PUMP HEADS

Also available with configuration:

■ Manual venting

■ Self venting

■ Compressed air

■ Viscous liquids



PVDF



PP



SS AISI316L



PMMA



P

ACCESSORIES



Foot filter with level probe



Injection valve 1/2" or 3/4"



V Series

Solenoid-driven dosing pumps

FEATURES

- Electronic flow rate adjustment
- Manual or automatic venting
- High-strength PTFE diaphragm
- Wall mounting
- Pump head and standard accessories in PVDF
- Also available in silenced and ultra-silenced versions

MAX FLOW RATE

16 l/h

MAX PRESSURE

20 bar

POWER SUPPLY

12 | 24 VDC
 24 | 115 | 230 VAC
 100-240 VAC

VENTING

Manual
Self



DIGITAL

VMS MF | PO

VMS MF multifunction + weekly timer

VMS PO built-in pH-meter or ORP-meter (read & adjust).
 Menu-settable parameter



ANALOG

V CL | CO

VCL constant with level control

VCO constant

PUMP HEADS

Also available with configuration:

- Manual venting
- Self venting



PVDF



PP

ACCESSORIES



Foot filter with
level probe



Injection valve
1/2"

WT Series

Solenoid-driven dosing pumps



WIFI



DIGITAL SERVICES



APP MY EMEC



ONLINE STATS



CUSTOMIZABLE

MAX FLOW RATE

3 l/h

MAX PRESSURE

5 bar

POWER SUPPLY

115 VAC

230 VAC

RGB DISPLAY

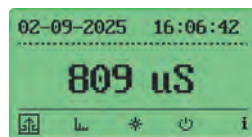

DOSING
Green

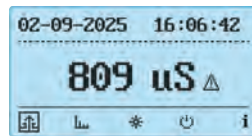

STAND-BY
White

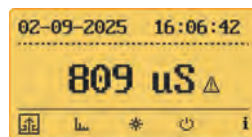

WARNING
Yellow

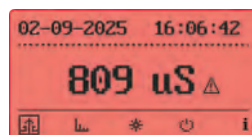

ALARM
Red



PERFORMANCE

Pressure

bar (psi)

up to 5 bar

Flow Rate

l/h

up to 3 l/h

gal/h

up to 0,79 gal/h

sPM Range

spm

45

FEATURES

- Dual Magnet, 45 strokes/min, continuously adjustable (1%-100%)
- Double Ball Check Valves
- Standard PVDF Hydraulic Components
- Wide LCD Display with Adaptive Backlighting
- Rotary Encoder Knob for Instrument Control
- PC + ABS Enclosure
- Flow Control Input
- Conductivity Measurement:
 - 0-3 mS / 0-30 mS (ECDINDPT)
 - 0-10 mS (ECDSINDPT)
 - 0-10 mS (ECDCCPT)
- Alarms: Level, No-Flow
- Digital Inputs Configurable as N.O. or N.C.
- Delayed Dosing Start
- Permanent Data Storage with System Log Viewable on Display
- Bluetooth® LE / 2.4 GHz Wi-Fi Connectivity for App and Remote Control
- Firmware Upgradeable via OTA (Over-the-Air)
- Installation Class II (IEC / EN 61010-1)
- Pollution Degree 2 (IEC / EN 61010-1 and IEC 60664-1)
- IP65 Protection Rating (IEC / EN 60529)
- Manual or Automatic Priming
- Integrated MODBUS
- Vertical Installation

INPUT

CONDUCTIVITY PROBE

INLET WATER METER

LEVEL 1 AND LEVEL 2

FLOW SENSOR

STANDBY MODE

OUTPUT

ALARM (VOLTAGE-FREE RELAY CONTACT)

MODBUS RTU PORT

PUMP 1 AND PUMP 2

BLEED (WATER DISCHARGE)

WDPHXX Series

Solenoid-driven dosing pumps with controller



DIGITAL SERVICES

MAX FLOW RATE

10 l/h

MAX PRESSURE

7 bar

POWER SUPPLY

230 VDC

115 VAC

VENTING

Manual

Self

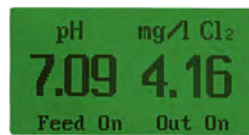

DOSING
Green

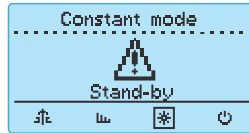

STAND-BY
White

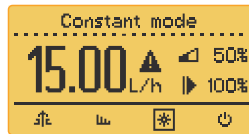

WARNING
Yellow

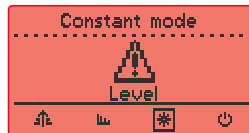

ALARM
Red

DIGITAL

WDPH RH | CL | CF | CA | OS

- WDPHRH** acid (pH) and disinfectant (ORP)
- WDPHCL** acid (pH) and chlorine
- WDPHCF** acid, flocculant (g/h) and 230VAC output for Cl
- WDPHCA** acid, algicide and 230VAC output for chlorine
- WDPHOS** acid (pH) and active oxygen

FEATURES

- Specific for swimming pools also in peristaltic version
- Control and regulating instrument with two built-in dosing pumps and standard PVDF accessories
- Wall mounting
- Easy programming with encoder and easy-nav navigation system
- Double pump head
- Optional: RS485 port for remote control (Wi-Fi, Ethernet, GSM, USB, Modbus)

PUMP HEADS

Also available with configuration:

- Manual venting
- Self venting



PVDF



PP

ACCESSORIES



Foot filter with
level probe



Injection valve
1/2"



R Series

Compressed air dosing pumps

FEATURES

- Specifications for car washes
- Constant dosing
- 3 installation modes: horizontal, wall, DIN rail
- Multiple installation (side by side)
- Mechanical volume adjustment 0-100% of single injection

MAX FLOW RATE

12 l/h

MAX PRESSURE

6 bar

POWER SUPPLY

Compressed Air



▲
RAC



▲
RACV



▲
RACP

R AC | ACV | ACP

- RAC** Pneumatic pump
- RACV** Pneumatic pump with solenoid valve
- RACP** Pneumatic pump with priming button

PUMP HEADS



Pump Head



Diaphragm

INSTALLATION OPTIONS



DIN rail



Wall

ACCESSORIES



Foot filter



Injection valve
1/2"

PRIUS D MF Series | DIAPHRAGM

Multifunction electronic control motor-driven pumps

PRIUS MF



DEFAULT GEAR BOX POSITION



ALTERNATIVE GEAR BOX POSITION

MAX FLOW RATE

1000 l/h

MAX PRESSURE

10* bar

POWER SUPPLY

115 VAC

230 VAC

VENTING

Manual

Self

FEATURES

- High-strength PTFE diaphragm
- Large display with EASYNAV navigation system and encoder knob
- Pump housing can be rotated 90 degrees for optimal installation
- Pump head in PVDF, PP, SS
- Accessories in PVDF, PP
- Integrated inverter
- Mechanical single injection volume adjustment (100-0%)
- Working modes: Constant - ppm - % - mlq - pause; timer; weekly; pulse; mA; Volt and Batch
- Level input
- Stand-by
- MODBUS (optional)
- IP65 motor (optional)
- 4/20 mA output (optional)
- *Also available PRIUS D MF HIGH PRESSURE versions up to 100 bar

PUMP HEADS



PVDF

PP

SS AISI316L

UMS

**For capacities above 350 l, with integral pressure relief valves

ATTENTION: In case of spare parts orders, the UMS pump head is supplied without the corresponding safety valve. If required, the safety valve must be ordered separately and will be charged additionally.



PRIUS P MF Series | PISTON

Multifunction electronic control motor-driven pumps

PRIUS MF

Modbus

2G 2D 3G 3D



MAX FLOW RATE

320 l/h

MAX PRESSURE

10 bar

POWER SUPPLY

230 VAC

115 VAC

VENTING

Manual

Self

DEFAULT GEAR BOX POSITION



ALTERNATIVE GEAR BOX POSITION

FEATURES

- Ceramic or Stainless Steel piston
- Display with EASYNAV navigation system and Encoder knob
- Pump housing can be rotated 90 degrees for optimal installation
- Integrated inverter
- Mechanical single injection volume adjustment (100-0%)
- Working modes: Constant - ppm - % - mlq - pause; weekly; pulse; mA; Volt and Batch
- Level input
- Stand-by
- MODBUS (optional)
- IP65 motor (optional)
- 4/20 mA output (optional)

PUMP HEADS



PP

SS AISI316L

PISTONS



CERAMIC
SIALOX96

SS
AISI420

PRIUS D Series | DIAPHRAGM

Motor-driven pumps

PRIUS



MAX FLOW RATE

1000 l/h

MAX PRESSURE

10* bar

POWER SUPPLY

115 VAC
 230 VAC
 380 VAC

VENTING

Manual
Self

FEATURES

- High-strength PTFE diaphragm
- SINGLE-PHASE or THREE-PHASE power supply
- Mechanical single injection volume adjustment (100%-0%)
- 0.18, 0.37 or 0.55 kW motor
- Standard pump head in PVDF
- 50 and 60 Hz motors
- IP65 motor (optional)
- Also available PRIUS D **HIGH PRESSURE** versions up to 100 bar*.
- **ATEX 3G/3D** and **ATEX 2G/2D** versions also available for use in potentially explosive atmospheres

PUMP HEADS



- * For capacities above 350 l, with integral pressure relief valves

ATTENTION: in case of spare parts orders, the UMS pump head is supplied without the corresponding safety valve. If required, the safety valve must be ordered separately and will be charged additionally.



PRIUS P Series | PISTON

Motor-driven pumps

PRIUS



MAX FLOW RATE

508 l/h

MAX PRESSURE

10 bar

POWER SUPPLY

380 VAC

220 VAC

115 VAC

VENTING

Manual

Self

FEATURES

- Ceramic or Stainless Steel piston
- Pump bodies in PP and Stainless Steel
- SINGLE-PHASE or THREE-PHASE power supply
- Mechanical adjustment of single injection volume (100%-0%)
- 0.18, 0.37 or 0.55 kW motor
- Pump head available in PP and SS
- 50 and 60 Hz motors
- IP65 motor (optional)
- ATEX 3G/3D and ATEX 2G/2D versions also available for use in potentially explosive atmospheres

PUMP HEADS



PP

SS AISI316L

PISTONS

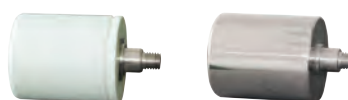

CERAMIC
SIALOX96

SS
AISI420

DOSING PUMPS ACCESSORIES

High efficiency products

CHEMICAL TANKS AND SAFETY BUNDS

UV-proof polyethylene containers for chemicals, complete with safety tanks, dosing pump and mixers. Capacity up to 1000 litres.

STANDARD TANK



ASSEMBLED TANK



Can be equipped with:

- 1 dosing pump (2 without mixer)
- 1 mixer
- 2 taps (filling and draining)1 outgassing valve
- 1 or 2 suction lances
- 2 level probes with filter (without mixer)
- 1 safety tank

SAFETY BUNDS



MIXERS

MIXVN/8
MIXVN/4
MIXVN/2



High speed mixer 1400 RPM. AISI rod with PVC coat/AISI shaft-PVC coated, different lengths available (depending on the container). "Marine" impeller.

MIXN/8
MIXN/4
MIXN/2



Slow speed mixer 1400 RPM. AISI rod with PVC coat/AISI shaft-PVC coated, different lengths available (depending on the container). 3-blade impeller.

MANUAL MIXERS

MIXN/MAN



Manual mixer. PVC shaft, different lengths (depending on the container).

MIX WITH PISTON



Manual mixer. PVC shaft, different lengths (depending on the container).

Note: for full technical characteristics please refer to the corresponding product data sheet.

**LASP**

Suction lances with level control, for tanks up to 1000 liters.

LINI

Injection lance for chemical dosing in hoses. Automatic cleaning system, available with and without tap.

MFKT

Multifunction valves for: pressure, safety, anti-siphon, bleed. Safety valve adjustment range: 1 to 18 bar. Pressure valve adjustment range: 1 to 5 bar. Delivery and connection fittings adaptable to different hose diameters. PVDF body and FKM B or EPDM o-rings.

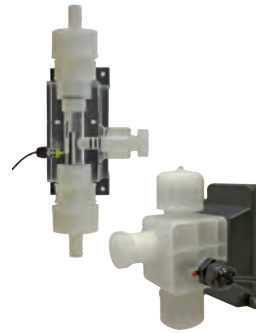
SEFL

Flow sensors to control the actual dosing of the chemical. They allow automatic pump re-priming.

PULSE OUTPUT METERS

High efficiency products

CWFA



Woltmann pulse-emitter water meter with dry dial for cold water.

CTFI



Pulse-emitter water meter for cold water.

CATFI - dry dial version

CWCA



Woltmann pulse-emitter water meter with dry dial for hot water.

CATCI



Pulse-emitter water meter for hot water.

CWFAT



Woltmann dry dial pulse-emitter water meter with Teflon-coated inside and outside.

CTFIT



Pulse-emitter water meter for cold water with Teflon-coated inside and outside.

Note: for full technical characteristics please refer to the corresponding product data sheet.



METERS - PULSES PER LITRE TABLE

CTFI / CTCI						
	Nominal size					
	15 - 1/2"	20 - 3/4"	25 - 1"	30 - 1 1/4"	40 - 1 1/2"	50 - 2"
Pulses per litre	1 - 2 - 4 - 35 - 70 - 140	1 - 2 - 4 - 22 - 90	1 - 2 - 4 - 12 - 24 - 48	1 - 2 - 4 - 12 - 24 - 48	1 - 2 - 4 - 9 - 18	1 - 2 - 4
Pulses per 10 litres	1 - 2 - 4	1 - 2 - 4	1 - 2 - 4	1 - 2 - 4	1 - 2 - 4	1 - 2 - 4
Pulses per 100 litres	1 - 2 - 4	1 - 2 - 4	1 - 2 - 4	1 - 2 - 4	1 - 2 - 4	1 - 2 - 4
Pulses per 1000 litres	1 - 2 - 4	1 - 2 - 4	1 - 2 - 4	1 - 2 - 4	1 - 2 - 4	1 - 2 - 4

CATFI / CATCI						
	Nominal size					
	15 - 1/2"	20 - 3/4"	25 - 1"	30 - 1 1/4"	40 - 1 1/2"	50 - 2"
Pulses per litre	1 - 2 - 4 - 35	1 - 2 - 4 - 22 - 90	1 - 2 - 4	1 - 2 - 4	1 - 2 - 4	1 - 2 - 4
Pulses per 10 litres	1 - 2 - 4	1 - 2 - 4	1 - 2 - 4	1 - 2 - 4	1 - 2 - 4	1 - 2 - 4
Pulses per 100 litres	1 - 2 - 4	1 - 2 - 4	1 - 2 - 4	1 - 2 - 4	1 - 2 - 4	1 - 2 - 4
Pulses per 1000 litres	1 - 2 - 4	1 - 2 - 4	1 - 2 - 4	1 - 2 - 4	1 - 2 - 4	1 - 2 - 4

CWFA / CWCA								
	Nominal size							
	50 - 2"	65 - 2 1/2"	80 - 3"	100 - 4"	150 - 6"	200 - 8"	250 - 10"	300 - 12"
Pulses per 10 litres	1 - 2 - 4	1 - 2 - 4	1 - 2 - 4					
Pulses per 100 litres	1 - 2 - 4	1 - 2 - 4	1 - 2 - 4	1 - 2 - 4	1 - 2 - 4			
Pulses per 1000 litres	1 - 2 - 4	1 - 2 - 4	1 - 2 - 4	1 - 2 - 4	1 - 2 - 4	1 - 2 - 4	1 - 2 - 4	1 - 2 - 4
Pulses per 10000 litres				1 - 2 - 4	1 - 2 - 4	1 - 2 - 4	1 - 2 - 4	1 - 2 - 4

Modem and external communication modules

For LD, MTOWER, WD and CENTURIO controller series

Internal PCB Module

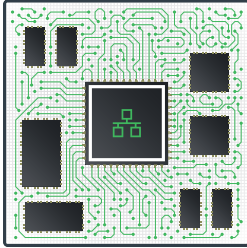

ETHERNET MODULE
for standard RJ45 network.

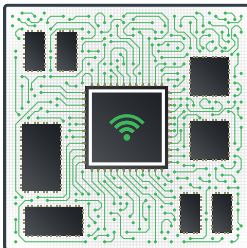

WIFI MODULE
for WIFI network.

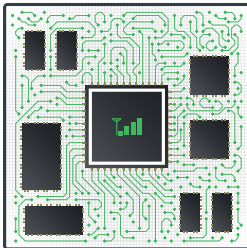

4G MODULE
for mobile network.

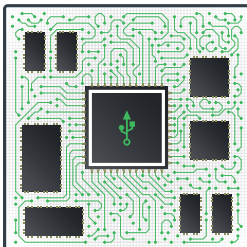

USB MODULE
for USB datalog recording.

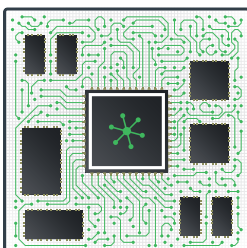

MODBUS MODULE
Serial communication module for PLC connection.

External IP65 Module

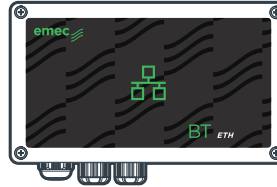

BT ETH
Ethernet controller for standard RJ45 network. IP65.



BT WIFI
Module for WIFI connection. IP65.

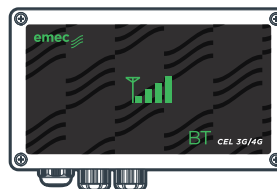

BT CEL
Modem for mobile network. IP65.

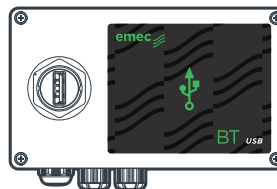

BT USB
USB module for USB datalog recording. IP65.



BT MODBUS
Serial communication module for PLC connection.



CENTURIO Series | PRO - TOWER - POOL

Up to 10 channels water treatment controllers

CENTURIO BASIC (USB, ETH, MODBUS, WIFI) | GSM



MODBUS



ETHERNET



WIFI



USB PORT



DIGITAL SERVICES



ONLINE STATS



CUSTOMIZABLE



ONLINE REMOTE CONTROL

ONLINE PARAMETER READING AND SETTING

UPLOADING AND DOWNLOADING OF SETTINGS AND DATALOGS

REMOTE SOFTWARE UPDATE

POWER SUPPLY

12 | 24 VDC

24 | 100 - 240 VAC

HARDWARE FEATURES

- Full color LCD touch display
- Large storage capacity for logs
- Configurable channels with add-on modules
- High-performance ARM A5 microprocessor

INPUTS

- ➔ 8 product level inputs
- ➔ Flow input
- ➔ 2 water meter inputs
- ➔ 1 RS485 bus probe input
- ➔ 6 slots for channels reading
- ➔ Ingresso stand-by

SOFTWARE FEATURES

- NIMBUS remote control
- Multi-language LINUX operating system
- Communication (standard) USB - ETHERNET - MODBUS - WIFI
- Communication (optional) GSM

OUTPUTS

- ➔ 8 proportional outputs
- ➔ 6 on/off outputs
- ➔ 2 "freecontact" on/off outputs
- ➔ 6 current outputs (0/4 - 20 mA)



CENTURIO is the digital controller series designed by EMEC to give you the best work experience in the multiparameter control of dosing systems. High-performance hardware and software of CENTURIO makes possible a simultaneous and complete control over all the main measurement parameters, while you have access to a rich set of functions and connection options that really enhance and simplify your work.

CENTURIO is compatible with NIMBUS, EMEC's proprietary online remote control system.

The CENTURIO series includes: CENTURIO PRO, the most complete solution for every application; CENTURIO TOWER, a control system specifically designed for cooling water treatment; CENTURIO POOL, specifically designed for swimming pool water treatment.

TOUCHSCREEN DISPLAY

LARGE 4" LCD FULL COLOR DISPLAY

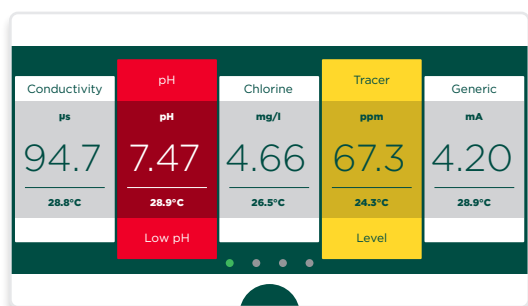

DASHBOARD

Quick data visualization on the dashboard

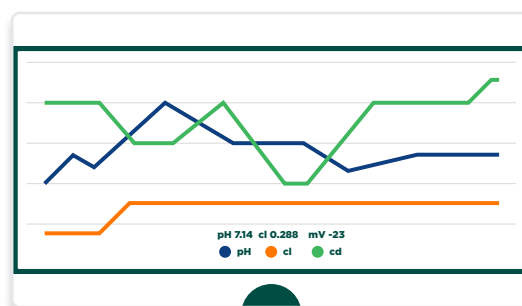

REAL-TIME STATS

Real-time graphs and graphs history

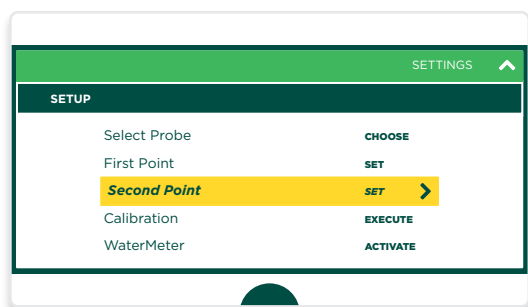

CHANNELS SETTINGS

Quick data visualization on the dashboard

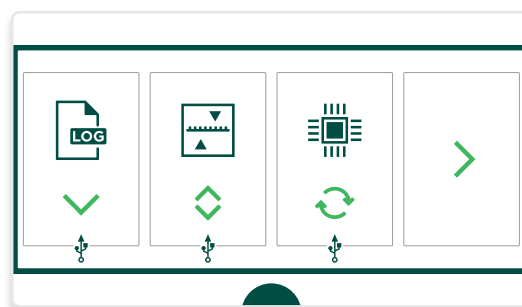

LOG MANAGEMENT

Large storage and download options

Centurio does not suffer data loss when disconnected from the power supply

UP TO 10 CHANNELS (6 ANALOG)

- CONDUCTIVITY
- INDUCTIVE CONDUCTIVITY
- pH
- ORP
- OPEN AMPEROMETRIC CELLS
- TRACERS
- mA INPUT
- TURBIDITY
- POTENTIOSTATIC (BROMINE/CHLORINE)
- DISSOLVED OXYGEN
- LASER LEVEL SENSOR
- CORROSION

- CLOSED AMPEROMETRIC CELLS

CHLORINE DIOXIDE	OZONE
FREE CHLORINE	PERACETIC ACID
TOTAL CHLORINE	BROMINE
HYDROGEN PEROXIDE	CHLORITES

LD Multichannel Series | LD MULTICHANNEL - LD MULTICHANNEL PLUS

Up to 2 channels plus temperature water treatment controllers

 **BASIC (MODBUS) | USB | ETH | GSM | WIFI**



DIGITAL SERVICES

LD Multichannel is the digital multi-parameter controller designed by EMEC capable of regulating two independent parameters with PID adjustment. The LD Multichannel controller is perfect for a wide range of applications including: general water treatment, cooling tower control, industrial chemical dosing, purification, agricultural use, and swimming pool disinfection.

OPTIONAL

- mA output
- power supply 12 VDC or 24 VDC

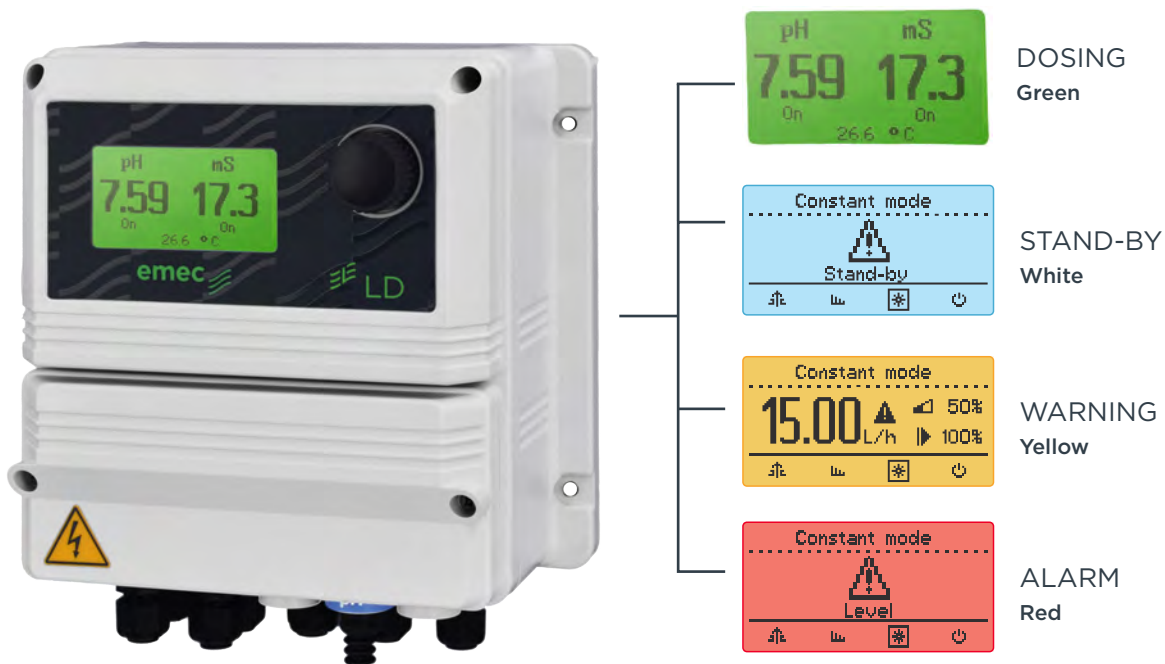

PARAMETERS

- pH
- ORP
- BROMINE/CHLORINE
- CONDUCTIVITY
- INDUCTIVE CONDUCTIVITY
- CHLORINE DIOXIDE
- HYDROGEN PEROXIDE
- OZONE
- PERACETIC ACID
- TURBIDITY
- CHLORITES

HARDWARE FEATURES

- LCD RGB display

SOFTWARE FEATURES

- NIMBUS remote control
- Multi-language
- Communication (optional)
ETHERNET - MODBUS - WIFI - GSM - USB

LD MULTICHANNEL PLUS FEATURES

- ➔ 5 relays (2 setpoints; alarm; probe cleaning; circulation relay)
- ➔ Probe cleaning
- ➔ PID
- ➔ Feed forward
- ➔ Proportional + meter reading
- ➔ "Line"

POWER SUPPLY

- 12 | 24 VDC
- 24 VAC
- 100-240 VAC

ALARMS

- ➔ General
- ➔ No flow
- ➔ Threshold exceeded
- ➔ Product level
- ➔ Maximum dosage
- ➔ Probe damaged

INPUTS

- ➔ Product level
- ➔ Flow
- ➔ Temperature probe
- ➔ Stand-by

OUTPUTS

- ➔ Alarm
- ➔ Probe cleaning with ETORB2
- ➔ Proportional
- ➔ Relay
- ➔ Flocculant pump (LDPHCL)
- ➔ mA



LDS Series | LDS - LDS PLUS

1 channel water treatment controllers with setpoints (LDS) or PID regulation (LDS PLUS)

LD BASIC (MODBUS) | USB | ETH | GSM | WIFI



DIGITAL SERVICES

LDS is the single-read digital controller designed by EMEC and is perfect for a wide range of applications including: general water treatment, cooling tower control, industrial chemical dosing, purification, agricultural use, and swimming pool disinfection.

OPTIONAL

- USB for LOG logging
- Current output (0/4 - 20 mA)
- Ethernet
- 4G modem
- WIFI module
- MODBUS protocol

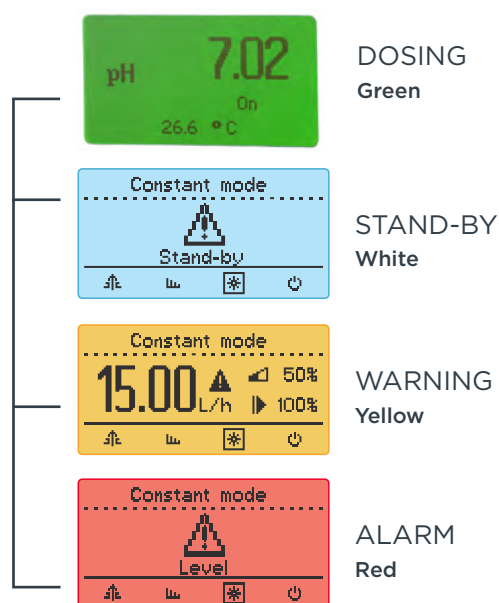

PARAMETERS

- pH
- ORP
- BROMINE/CHLORINE
- CONDUCTIVITY
- INDUCTIVE CONDUCTIVITY
- CHLORINE DIOXIDE
- HYDROGEN PEROXIDE
- OZONE
- PERACETIC ACID
- TURBIDITY
- DISSOLVED OXYGEN
- CHLORITES

HARDWARE FEATURES

- LCD RGB display

SOFTWARE FEATURES

- NIMBUS remote control
- Multi-language
- Communication (optional)
ETHERNET - MODBUS - WIFI - GSM - USB

LDS PLUS FEATURES

- ➔ 5 relays (2 setpoints; alarm; probe cleaning; circulation relay)
- ➔ Probe cleaning
- ➔ PID
- ➔ Feed forward

POWER SUPPLY

- 12 | 24 VDC
- 24 VAC
- 100-240 VAC

ALARMS

- ➔ General
- ➔ No flow
- ➔ Threshold exceeded
- ➔ Product level
- ➔ Maximum dosage
- ➔ Probe damaged

INPUTS

- ➔ Product level
- ➔ Flow
- ➔ Temperature probe
- ➔ Stand-by
- ➔ mA water meter (only LDS PLUS)

OUTPUTS

- ➔ Alarm
- ➔ Proportional
- ➔ Relay
- ➔ mA (optional for LDS)
- ➔ Set points (only LDS PLUS)
- ➔ Opto coupled (only LDS PLUS)

MTOWER Series | MTOWER - MTOWER PLUS

Up to 3 channels cooling towers controllers

MTOWER BASIC | USB | ETH | GSM | WIFI | MODBUS



MTOWER PLUS manage simultaneously three parameters: pH or ORP, chlorine, conductivity or inductive conductivity (to specify on order) and temperature.

MTOWER 2CH manage simultaneously two parameters: pH or ORP or chlorine, conductivity or inductive conductivity (to specify on order) and temperature.

MTOWER 1CH manages one parameter: conductivity or inductive conductivity (to specify on order) and temperature.

They can be remotely controlled through the exclusive web management system NIMBUS.

OPTIONAL

- inductive conductivity probe
- USB for log logging
- Current output (0/4 - 20 mA)
- Ethernet
- 4G modem
- WIFI module
- MODBUS protocol



MTOWER PLUS 3 CH

MTOWER PLUS CD/PH/CL Conductivity, pH and chlorine

MTOWER PLUS CD/PH/RH Conductivity, pH and ORP



MTOWER 2 CH

MTOWER CD/PH Conductivity, pH

MTOWER CD/RH Conductivity, ORP

MTOWER CD/CL Conductivity, chlorine

MTOWER 1 CH

MTOWER CD Conductivity

PARAMETERS

pH ORP CHLORINE

CONDUCTIVITY OR INDUCTIVE CONDUCTIVITY

TEMPERATURE TRACERS

MTOWER FEATURES

- Conductivity for "blowdown"
- 2 Timers for biocides
- Pre-bleed
- Lockout

ALARMS

- ➔ No water flow
- ➔ 3 product level
- ➔ Bleed timeout

INPUTS

- ➔ 6 product level
- ➔ 2 water meter
- ➔ Flusso
- ➔ Sonda temperatura
- ➔ Stand-by

OUTPUTS

- ➔ mA

POWER SUPPLY

- 115 VAC
- 230 VAC



RACK MOUNT Series | JA - J DIGITAL - DIN DIGITAL

1 channel plus temperature water treatment controllers



JA PRO RACK (96x96 mm)

JA PRO	Single reading
JA PRO PH	pH
JA PRO RH	ORP
JA PRO CL	Chlorine (Total - Free), Chlorine Dioxide, Hydrogen Peroxide, Ozone, Bromine, Paracetic Acid, Chlorites
JA PRO CD	Conductivity
JA PRO CD IND	Inductive Conductivity

ALARMS

- ➔ No water flow

INPUTS

- ➔ Flow
- ➔ Temperature probe
- ➔ Probe
- ➔ Stand-by

OUTPUTS

- ➔ 1 proportional
- ➔ 2 set points outputs / Free contact
- ➔ 1 alarm
- ➔ 1 current

POWER SUPPLY

115	VAC
230	VAC



J DIGITAL RACK (96x48 mm)

J DIGITAL	Single reading
J DIGITAL PH	pH
J DIGITAL RH	ORP
J DIGITAL CL	Chlorine (Total - Free), Chlorine Dioxide, Hydrogen Peroxide, Ozone, Bromine, Paracetic Acid, Chlorites
J DIGITAL CD	Conductivity
J DIGITAL O3	Ozone
J DIGITAL CLO2	Chlorine Dioxide
J DIGITAL TEMP	Temperature

POWER SUPPLY

12 24	VDC
115 230	VAC

J DIGITAL / DIN DIGITAL INPUTS

- ➔ Flow input
- ➔ Temperature probe input
- ➔ Probe input



DIN DIGITAL DIN RAIL (6 modules)

DIN DIGITAL	Single reading
DIN DIGITAL PH	pH
DIN DIGITAL RH	ORP
DIN DIGITAL CL	Chlorine (Total - Free), Chlorine Dioxide, Hydrogen Peroxide, Ozone, Bromine, Paracetic Acid, Chlorites
DIN DIGITAL CD	Conductivity
DIN DIGITAL O3	Ozone
DIN DIGITAL CLO2	Chlorine Dioxide
DIN DIGITAL TEMP	Temperature

POWER SUPPLY

12 24	VDC
115 230	VAC

J DIGITAL / DIN DIGITAL OUTPUTS

- ➔ Current output
- ➔ 2 set point / relay / free contact outputs

PROBES

SCL - Closed amperometric cells



Chlorine dioxide (hot/cold water), Free chlorine (organic/inorganic), Total chlorine, Hydrogen peroxide, Ozone, Paracetic acid, Bromine, Chlorites for fresh water.

ECL - Open amperometric cells

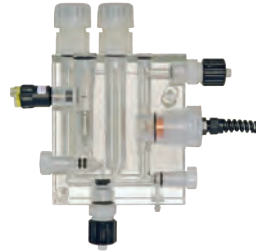

Free chlorine (organic and inorganic) for fresh and salt water.

EPH - pH / ERH - ORP



Working temperature max 100° C (max 135° C for EPHSN6/GK pH probes).
Max working pressure 7 bar.

EOLUM - Dissolved oxygen



Max working temperature 50° C.
Max working pressure 10 bar.

ETORB2 - Turbidity



Working temperature max 40° C
Max working pressure 2 bar

ETRC2 - Tracers



Max. working temperature 50° C
Max working pressure 7 bar

EFL - Fluorine, Ion Selective



Working temperature max 70° C
Max working pressure 7 bar

ECDHL - Conductivity, platinum electrodes



Working temperature max 70° C
Max working pressure 7 bar

Notes: see the relevant product data sheet for complete technical characteristics.



ECDC - Conductivity, graphite electrodes



Working temperature max
60° C
Max working pressure 7
bar

ECDI - Conductivity, stainless steel electrodes



Working temperature max
60° C
Max working pressure 7
bar

EICD - Conductivity, stainless steel body



Working temperature max
130° C
Max working pressure 15 bar

ECDIND PT - Inductive conductivity



Reading scale up to 300
mS
Working temperature max
85° C
Working pressure max 8
bar

ECDSIND PT - Inductive conductivity



Readout scale 0-3 or 0-10
mS
Working temperature max
85° C
Working pressure max 8 bar

PROBES ACCESSORIES

NPED



Outflow electrode holder.
Working temperature
0°/50° C
Maximum pressure 5 bar

PEF



Electrode holder for pH,
ORP and closed amperometric cell probes.

PEL



In-line electrode holder.
Max. working temperature
60° C
Working pressure max 7 bar

NFIL



Filters.
Working temperature max
60° C
Working pressure max 7 bar

PEC



Immersion electrode holder.
Options for Compressed air and probe cleaning system (automatic or manual control).

MANIFOLD



Conductivity electrode holder with flow sensor and optional motorized valve with two injection points.

Maximum pressure 8 bar
Maximum temperature 75° C

BUFFER SOLUTIONS



Buffer solutions of reference for probe calibrations.

Notes: see the relevant product data sheet for complete technical characteristics.



PRE-CONFIGURED SOLUTIONS, SKIDS, CABINS AND DOSING STATIONS

Our solutions

EMEC dosing pumps and measuring and control systems can be assembled with probes and accessories on panels according to specific combinations in order to offer turnkey all-in-one solutions for cooling tower systems.

Pre-assembled solutions may have:

- ➔ pumps, controllers or elements owned by the customer and assembled by EMEC
- ➔ customised logos
- ➔ backgrounds chosen by the customer
- ➔ customised sizes
- ➔ custom power panels

SYSTEMS ON SKIDS OR IN CUSTOM-MADE CABINS

The Stainless Steel or plastic skid is designed and built on client requirements.

In addition to the solution on skids, it is possible to create dosing plants in a cabin, screen guard or with window.

Electric control panels designed to control all the assembled solution.

The final product includes electrical and piping hook-ups ready for installation.

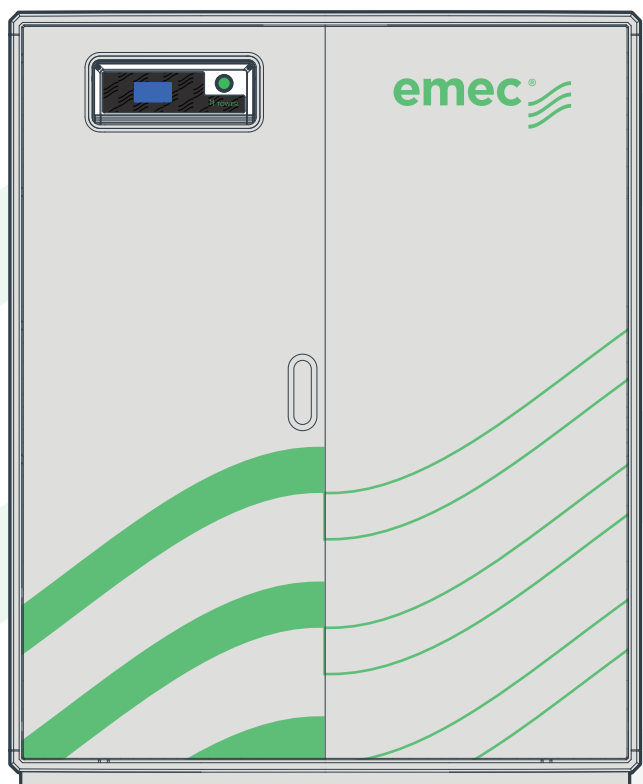
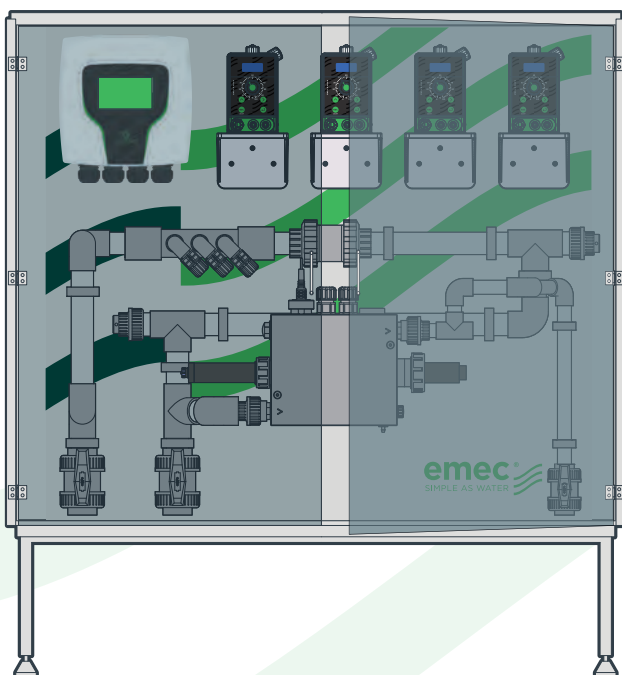



Chlorine dioxide disinfection systems

 **LOTUS** BASIC | USB | ETH | GSM | WIFI | MODBUS



DIGITAL SERVICES

RELIABLE AND SAFE

The use of chlorine dioxide in the treatment of water has been driven by an increased awareness of biological related health issues. **EMEC LOTUS** chlorine dioxide generators can be used in a variety of industries for control of micro-organisms in water systems and are especially recommended for Legionella reduction, control and prevention in cold and hot water systems. **Micro-organisms are killed in 5 minutes in a safety way.**

LOTUS chlorine dioxide based biological control systems are reliable and safe, being designed so there is no requirement to handle ClO₂ as a gas: two liquid chemicals, Hydrochloric Acid (HCl) and Sodium Chlorite (NaClO₂), react together to form the chlorine dioxide required, so there is no ClO₂ gas or concentrated solutions outside of the process application.

Thanks to EMEC online control system NIMBUS, you will also be able to monitor and interact with **LOTUS** systems from everywhere and through a simple but powerful web interface.

Overview table

Lotus configuration performances

MODELS	MAX FLOW RATE ClO ₂	MAX CHEMICAL CONSUMPTION*	CONCENTRATION OF CHEMICALS	REACTOR	MAX PRESSURE (FEED WATER)	MAX WORKING PRESSURE***
AIR 10	10 g/h	0,25 l/h	9% HCl 7,5% NaClO ₂	PVC	2 bar	8 bar
AIR 30	30 g/h	0,75 l/h			3 bar	5 bar
AIR 60	60 g/h	1,5 l/h			3 bar	5 bar
MINI 8	8 g/h	0,2 l/h	9% HCl 7,5% NaClO ₂	PVC	5 bar	8 bar
MINI 20	20 g/h	0,5 l/h			5 bar	8 bar
MAXI 80	80 g/h	2 l/h	9% HCl 7,5% NaClO ₂	PVC	**	8 bar
MAXI 160	160 g/h	4 l/h				8 bar
MAXI 240	240 g/h	6 l/h				8 bar
MAXI 400	400 g/h	10 l/h				8 bar
MAXI 600	600 g/h	15 l/h				8 bar
MAXI 800	800 g/h	20 l/h				5 bar
MAXI 1000	1000 g/h	25 l/h				3 bar
ULTRA 500	500 g/h	3,15 l/h	33% HCl 25% NaClO ₂	PVDF	**	5 bar
ULTRA 1000	1000 g/h	6,3 l/h				5 bar
ULTRA 2000	2000 g/h	12,6 l/h				5 bar
ULTRA 3000	3000 g/h	18,9 l/h				3 bar
ULTRA 4000	4000 g/h	25,2 l/h				2 bar
EASY 8	8 g/h	0,2 l/h	9% HCl 7,5% NaClO ₂	PVC	**	8 bar
EASY 20	20 g/h	0,5 l/h				8 bar
EASY 40	40 g/h	1 l/h				8 bar
EASY 80	80 g/h	2 l/h				8 bar

* Max chemicals consumption value is referred to a single reagent, multiply by two to obtain the total consumption of liters/hour

** Depends on system pressure (max 8 bar)

*** For higher pressures use an external pump

Lotus Air

Pressure-less chlorine dioxide generator from 10 to 60 g/h

 **LOTUS** AIR BASIC | USB | ETH | GSM | WIFI | MODBUS



DIGITAL SERVICES

LOTUS AIR is a pressure-less chlorine dioxide generator useful for those applications in which several injection points are required. Chlorine Dioxide is produced from diluted base chemicals: acid-chlorite process by Hydrochloric Acid (HCl 9%) and Sodium Chlorite (NaClO₂ 7,5%).

Chlorine dioxide produced by **LOTUS AIR** is stocked into a tank and then dosed in the pipeline.

Its elegant cover preserves the cleanliness of the inner components and their integrity.

ADVANTAGES

- Reaction at ambient pressure
- Multi-point injection
- No emission
- Diluted chemicals

OPTIONAL

Also available equipped with a ClO₂ probe (SVCL2 or SVCL17) or a ORP probe (ERH), a probe holder and a filter.

PANEL

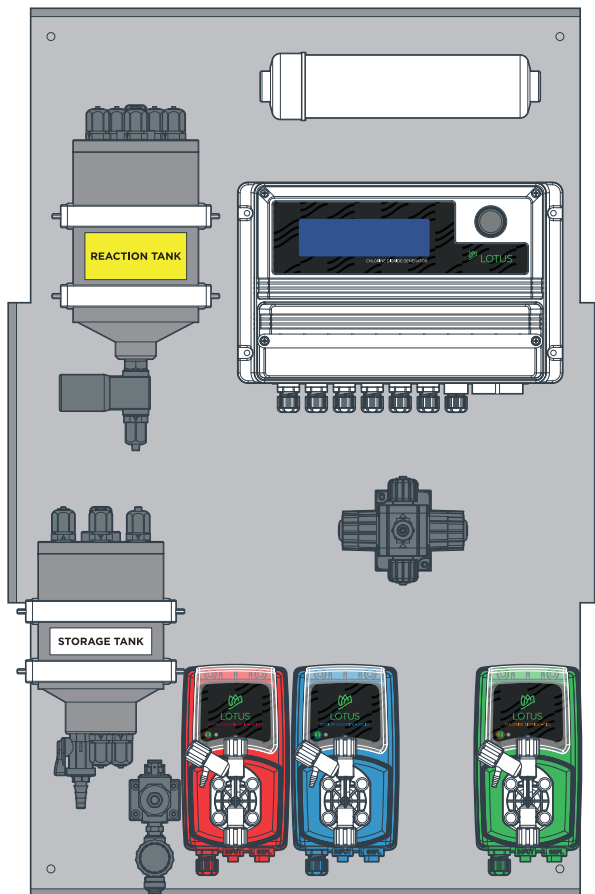

COVER

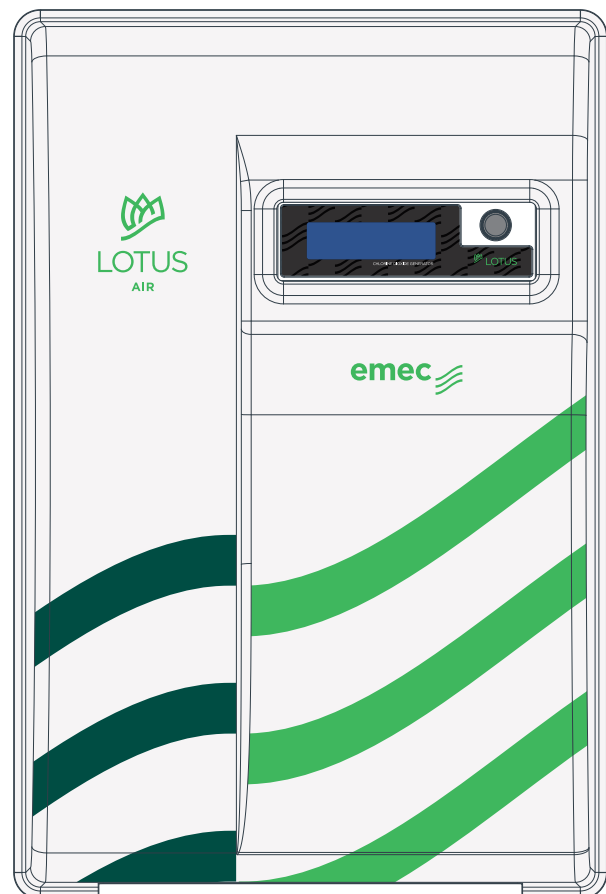

ALARMS

- ➔ product alarm
- ➔ product filling times alarm
- ➔ reactor levels alarm
- ➔ chlorine dioxide sensor alarm
- ➔ sepr alarm
- ➔ reading thresholds alarm

INPUTS

- ➔ water meter input
- ➔ stand-by input
- ➔ levels inputs
- ➔ 0-4/20 mA input
- ➔ probes inputs

OUTPUTS

- ➔ 0-4/20 mA output
- ➔ alarm output
- ➔ RS485 output



MODELS

- AIR 10 / AIR 30 / AIR 60



ONLINE STATS



CUSTOMIZABLE



APP



REMOTE CONTROL

GAS SENSOR

- LOTUS AIR with gas sensor detection (optional).

FUNCTIONS

- BATCH chlorine dioxide production
- ClO₂ dosing in several mode
- Alarms: products, water, emptying
- Water meter input
- Stand-by input
- Real time production data
- Pumps and SEFL flow sensors monitoring
- Service due date
- NIMBUS communication
- Flow control input (flow alarm)
- Tank level controls (level alarm)
- USB data log (optional)
- Ethernet module (optional)
- GSM internal modem (optional)
- MODBUS module (optional)
- WIFI module (optional)
- ClO₂ concentration in water measurement and control
- mA output

FEATURES

- ClO₂ concentration: 2 g/l
- HCl (red), NaClO₂ (blue) and ClO₂ (green) metering pumps
- MFKT/V multifunction valve as pressure,
- safety, anti-syphon and bleed
- Double chamber: reaction and storage
- Filtro carboni attivi
- ASA or fiber glass enclosure
- IP65 protection (NEMA4x) of LOTUS controller and pumps
- Wheel control for easy programming
- Working temperature: 0-45°C (32-110°F)

Overview table

Lotus Air configuration performances

MODELS	MAX FLOW RATE ClO ₂	MAX CHEMICAL CONSUMPTION*	CONCENTRATION OF CHEMICALS	REACTOR	MAX PRESSURE (FEED WATER)	MAX WORKING PRESSURE***
AIR 10	10 g/h	0,25 l/h	9% HCl	PVC	2 bar	8 bar
AIR 30	30 g/h	0,75 l/h	7,5% NaClO ₂		3 bar	5 bar
AIR 60	60 g/h	1,5 l/h			3 bar	5 bar

* Max chemicals consumption value is referred to a single reagent, multiply by two to obtain the total consumption of liters/hour

** Depends on system pressure (max 8 bar)

*** For higher pressures use an external pump

Lotus Mini

Chlorine dioxide generator from 8 to 20 g/h

 **LOTUS** MINI BASIC | USB | ETH | GSM | WIFI | MODBUS



DIGITAL SERVICES

LOTUS MINI is an all-round solution for all your need for water disinfection. It is safe and solid. Chlorine Dioxide is produced from diluted base chemicals: acid-chlorite process by Hydrochloric Acid (HCl 9%) and Sodium Chlorite (NaClO₂ 7,5%).

Its elegant cover preserves the cleanliness of the inner components and their integrity. Chlorine dioxide produced by **LOTUS MINI** can be proportional to the circulating water flow or based on a measured setpoint.

There is no storage of chlorine dioxide therefore there is no chlorine dioxide gas or concentrated solutions outside of the process application.

ADVANTAGES

- Reaction at controlled pressure
- High degree of stability of the chlorine dioxide solution
- No ClO₂ loss due to closed reaction chamber
- Diluted chemicals

OPTIONAL

Also available equipped with a ClO₂ probe (SVCL2 or SVCL17) or a ORP probe (ERH), a probe holder and a filter.

PANEL

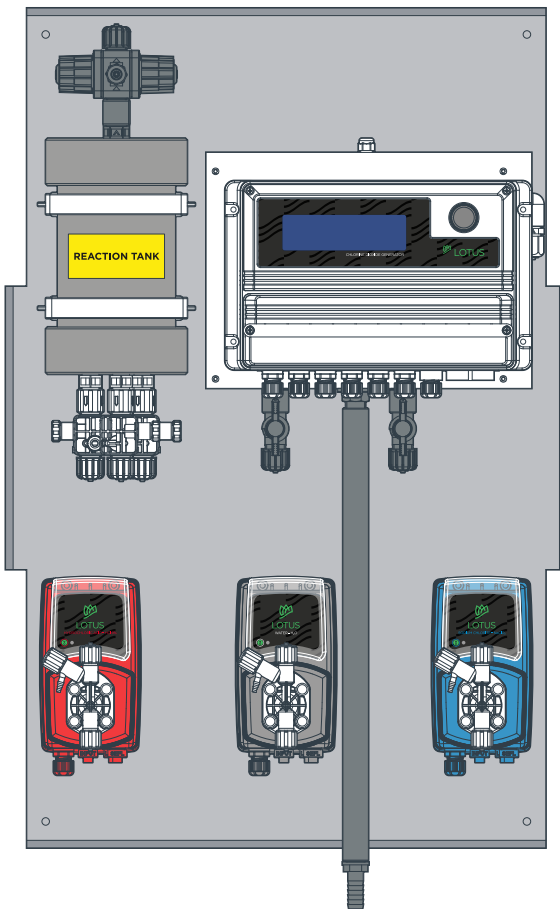

COVER

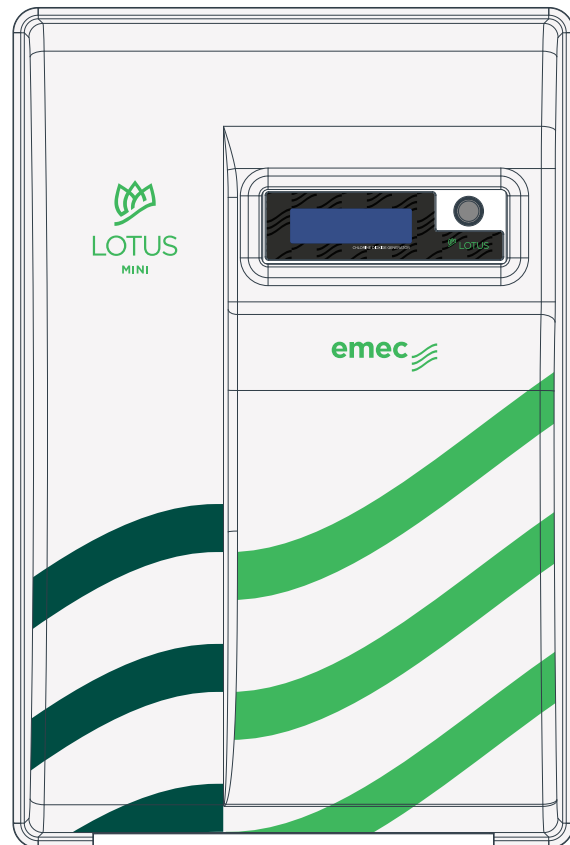

ALARMS

- ↪ sepr alarm
- ↪ chlorine dioxide sensor alarm
- ↪ reactor leakage alarm

INPUTS

- ↪ sefl input
- ↪ stand-by input
- ↪ levels inputs
- ↪ temperature input
- ↪ probes inputs

OUTPUTS

- ↪ pumps output
- ↪ RS485 output
- ↪ 0-4/20 mA output
- ↪ alarm output



MODELS

- MINI 8 / MINI 20



ONLINE STATS



CUSTOMIZABLE



APP



REMOTE CONTROL

GAS SENSOR

- LOTUS MINI with gas sensor detection (optional).

FUNCTIONS

- Instantaneous ClO₂ production
- ClO₂ dosing in several mode
- Flow control input (flow alarm)
- Tank level controls (level alarms)
- Water meter input
- Stand-by input
- Real time production data
- Pumps and SEFL flow sensors monitoring
- Permanent data storage with system data log (on Logbook

menu)

- NIMBUS communication
- USB data log (optional)
- Ethernet module (optional)
- GSM internal modem (optional)
- MODBUS module (optional)
- WIFI module (optional)
- Service due date
- mA output

FEATURES

- ClO₂ concentration: 2 g/l
- Flow control input (flow alarms)
- Tank level control (level alarms)
- HCl (red), NaClO₂ (blue) and dilution water (grey) metering pumps
- 3 SEFL pump dosing check
- Filtro carboni attivi
- MFKT/V multifunction valve as pressure, safety, anti-syphon and bleed valve
- PVC reaction chamber
- ASA or fiber glass enclosure
- IP65 protection (NEMA4x) of LOTUS controller and pumps
- Wheel control for easy programming
- Working temperature: 0-45°C (32-110°F)

Overview table

Lotus Mini configuration performances

MODELS	MAX FLOW RATE ClO ₂	MAX CHEMICAL CONSUMPTION*	CONCENTRATION OF CHEMICALS	REACTOR	MAX PRESSURE (FEED WATER)	MAX WORKING PRESSURE***
MINI 8	8 g/h	0,2 l/h	9% HCl	PVC	5 bar	8 bar
MINI 20	20 g/h	0,5 l/h	7,5% NaClO ₂		5 bar	8 bar

* Max chemicals consumption value is referred to a single reagent, multiply by two to obtain the total consumption of liters/hour

** Depends on system pressure (max 8 bar)

*** For higher pressures use an external pump

Lotus Maxi

Chlorine dioxide generator from 80 to 1000 g/h

 **LOTUS** MAXI **BASIC | USB | ETH | GSM | WIFI | MODBUS**



DIGITAL SERVICES

LOTUS MAXI is one of the largest product among EMEC Chlorine Dioxide generators and is used in all those cases in which there is need of a big production, such as large water treatment plants. Chlorine Dioxide is produced from diluted base chemicals: acid-chlorite process by Hydrochloric Acid (HCl 9%) and Sodium Chlorite (NaClO₂ 7,5%).

Chlorine dioxide produced by **LOTUS MAXI** is set to be proportional to the circulating water flow or based on a setpoint, it is then dosed into the water flow.

It can also be controlled remotely via the web application NIMBUS through a 2G/3G modem or a lan adapter, while Modbus is available as option.

ADVANTAGES

- Reaction at controlled pressure
- High degree of stability of the chlorine dioxide solution
- No ClO₂ loss due to closed reaction chamber
- Diluted chemicals

OPTIONAL

Also available equipped with a ClO₂ probe (SVCL2 or SVCL17) or a ORP probe (ERH), a probe holder and a filter.

PANEL

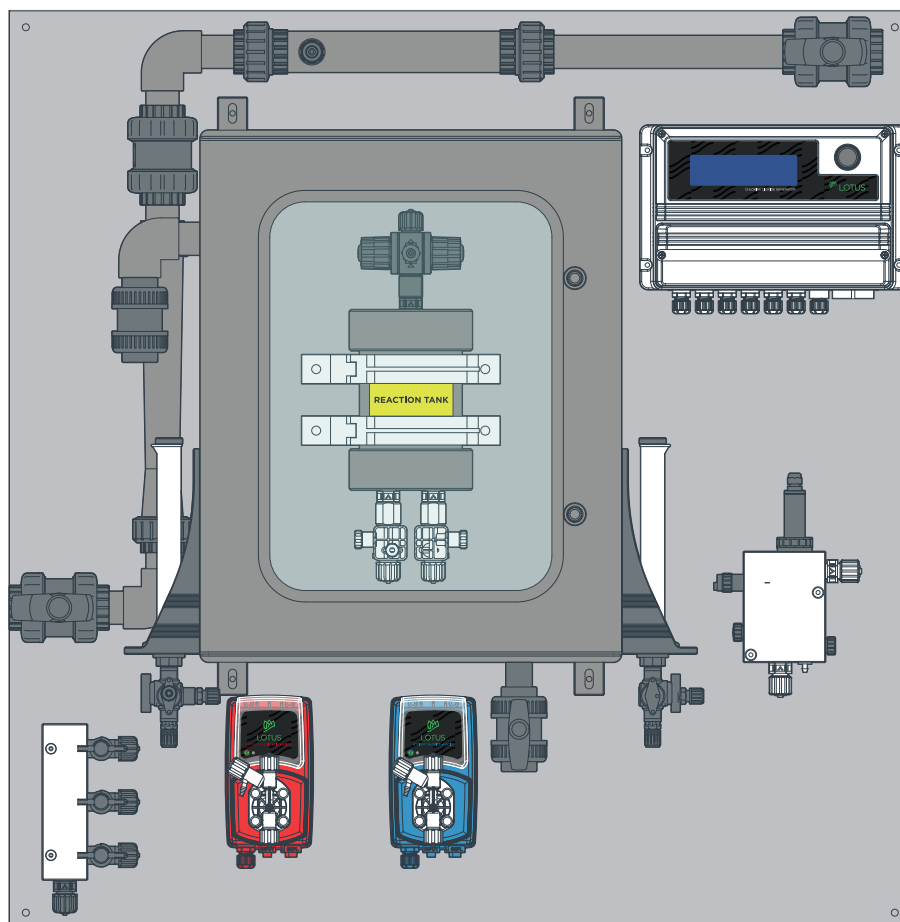

ALARMS

- ↪ sepr alarm
- ↪ chlorine dioxide sensor alarm
- ↪ reactor leakage alarm

INPUTS

- ↪ sefl input
- ↪ stand-by input
- ↪ levels inputs
- ↪ temperature input
- ↪ probes inputs

OUTPUTS

- ↪ pumps output
- ↪ RS485 output
- ↪ 0-4/20 mA output
- ↪ alarm output



MODELS

- MAXI 80 / MAXI 160 / MAXI 240 / MAXI 400 / MAXI 600 / MAXI 800 / MAXI 1600



ONLINE STATS



CUSTOMIZABLE



APP



REMOTE CONTROL

GAS SENSOR

- LOTUS MAXI with gas sensor detection (optional).

FUNCTIONS

- Instantaneous ClO₂ production
- ClO₂ dosing in several mode
- Flow control input (flow alarm)
- Tank level controls (level alarms)
- Water meter input
- Stand-by input
- Real time production data
- Pumps and SEFL flow sensors monitoring
- Permanent data storage with system data log (on Logbook

menu)

- NIMBUS communication
- USB data log (optional)
- Ethernet module (optional)
- GSM internal modem (optional)
- MODBUS module (optional)
- WIFI module (optional)
- Service due date
- mA output

FEATURES

- ClO₂ concentration: 2 g/l
- Flow control input (flow alarms)
- Tank level control (level alarms)
- HCl (red) and NaClO₂ (blue) metering pumps
- 3 SEFL pump dosing check
- Filtro carboni attivi
- MFKT/V multifunction valve as pressure, safety, anti-syphon

and bleed valve

- PVC reaction chamber
- ASA or fiber glass enclosure
- IP65 protection (NEMA4x) of LOTUS controller and pumps
- Wheel control for easy programming
- Working temperature: 0-45°C (32-110°F)

Overview table

Lotus Maxi configuration performances

MODELS	MAX FLOW RATE ClO ₂	MAX CHEMICAL CONSUMPTION*	CONCENTRATION OF CHEMICALS	REACTOR	MAX PRESSURE (FEED WATER)	MAX WORKING PRESSURE***
MAXI 80	80 g/h	2 l/h				8 bar
MAXI 160	160 g/h	4 l/h				8 bar
MAXI 240	240 g/h	6 l/h				8 bar
MAXI 400	400 g/h	10 l/h	9% HCl	PVC	**	8 bar
MAXI 600	600 g/h	15 l/h	7,5% NaClO ₂			8 bar
MAXI 800	800 g/h	20 l/h				5 bar
MAXI 1000	1000 g/h	25 l/h				3 bar

* Max chemicals consumption value is referred to a single reagent, multiply by two to obtain the total consumption of liters/hour

** Depends on system pressure (max 8 bar)

*** For higher pressures use an external pump

Lotus Ultra

Chlorine dioxide generator from 500 to 4000 g/h

 **LOTUS ULTRA** BASIC | USB | ETH | GSM | WIFI | MODBUS



LOTUS ULTRA is the largest product among EMEC Chlorine Dioxide generators and is used in all those cases in which there is need of a big production, such as large water treatment plants.



DIGITAL SERVICES

Chlorine Dioxide is produced from concentrated base chemicals: acidchlorite process by Hydrochloric Acid (HCl 33%) and Sodium Chlorite (NaClO₂ 25%).

Chlorine dioxide produced by **LOTUS ULTRA** is set to be proportional to the circulating water flow or based on a setpoint, it is then dosed into the water flow.

ADVANTAGES

- Reaction at controlled pressure
- High degree of stability of the chlorine dioxide solution
- No ClO₂ loss due to closed reaction chamber
- Diluted chemicals

SKID

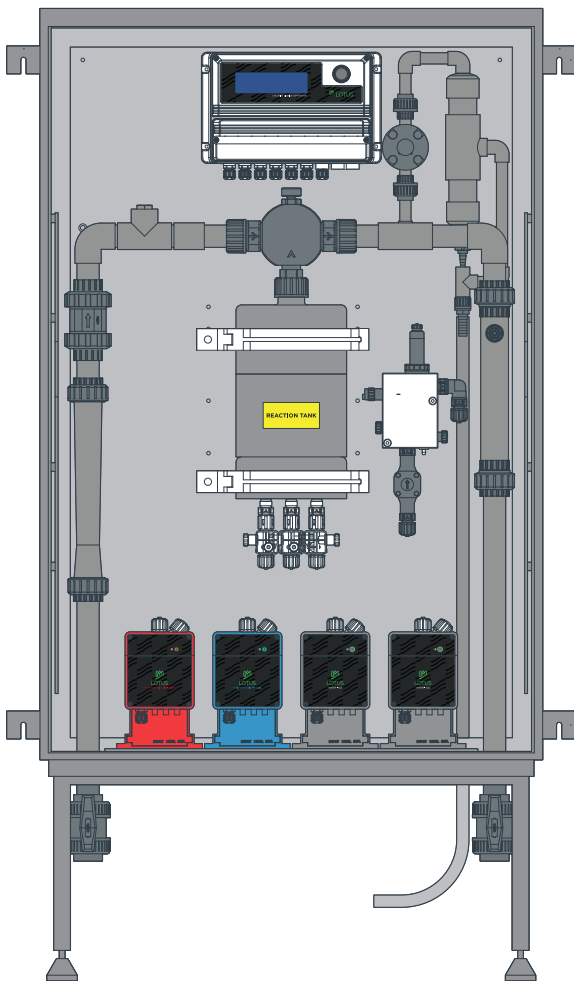

PANEL

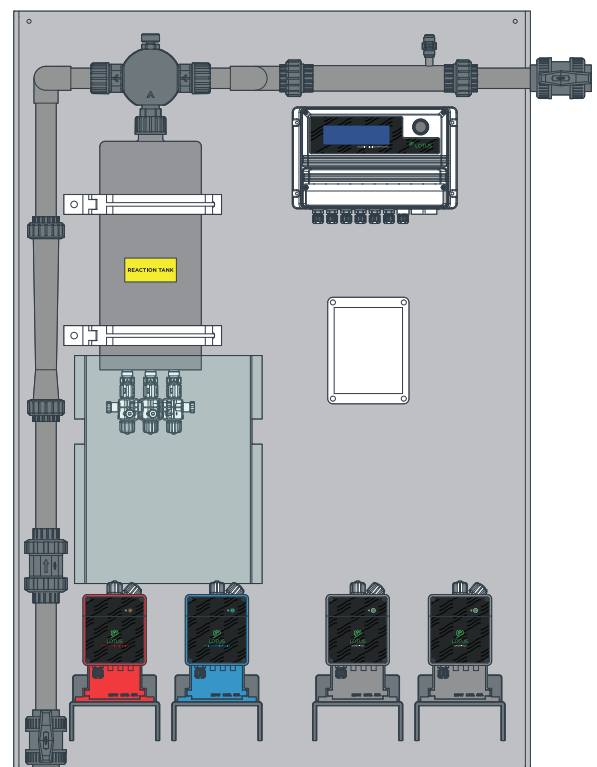

ALARMS

- ↪ sepr alarm
- ↪ chlorine dioxide sensor alarm
- ↪ reactor leakage alarm

INPUTS

- ↪ sefl input
- ↪ stand-by input
- ↪ levels inputs
- ↪ temperature input
- ↪ probes inputs

OUTPUTS

- ↪ pumps output
- ↪ RS485 output
- ↪ 0-4/20 mA output
- ↪ alarm output



MODELS

- ULTRA 500 / ULTRA 1000 / ULTRA 2000 / ULTRA 3000 / ULTRA 4000



ONLINE STATS



CUSTOMIZABLE



APP



REMOTE CONTROL

GAS SENSOR

- LOTUS ULTRA with gas sensor detection (optional).

FUNCTIONS

- Instantaneous ClO₂ production
- ClO₂ dosing in proportional mode
- Flow control input (flow alarm)
- Tank level controls (level alarms)
- Water meter input
- Stand-by input
- Real time production data
- Pumps and SEFL flow sensors monitoring
- Permanent data storage with system data log (on Logbook menu)

FEATURES

- Service due date
- LOTUS controller
- HCl (red) and NaClO₂ (blue) metering pumps
- 2 pumps for dilution water (grey)
- 4 SEFL flow sensors as security
- MFKT/V multifunction valve as pressure, safety, anti-syphon and bleed valve
- PVDF reaction chamber
- IP65 protection (NEMA4x) of LOTUS controller
- ENCODER wheel control
- Working temperature: 0-45°C (32-110°F)
- mA output
- ClO₂ probe reading
- Temperature probe reading (probe and accessories not included)

Overview table

Lotus Ultra configuration performances

MODELS	MAX FLOW RATE ClO ₂	MAX CHEMICAL CONSUMPTION*	CONCENTRATION OF CHEMICALS	REACTOR	MAX PRESSURE (FEED WATER)	MAX WORKING PRESSURE***
ULTRA 500	500 g/h	3,15 l/h				5 bar
ULTRA 1000	1000 g/h	6,3 l/h				5 bar
ULTRA 2000	2000 g/h	12,6 l/h	33% HCl	PVDF	**	5 bar
ULTRA 3000	3000 g/h	18,9 l/h	25% NaClO ₂			3 bar
ULTRA 4000	4000 g/h	25,2 l/h				2 bar

* Max chemicals consumption value is referred to a single reagent, multiply by two to obtain the total consumption of liters/hour

** Depends on system pressure (max 8 bar)

*** For higher pressures use an external pump

Lotus Easy

Chlorine dioxide generator from 8 to 80 g/h



LOTUS EASY

BASIC | USB | ETH | GSM | WIFI | MODBUS



DIGITAL SERVICES

LOTUS EASY is the best solution if you want a simple but professional way to produce chlorine dioxide, thanks to an integrated All-in-One Controller equipped with two metering pumps. Chlorine Dioxide is produced from concentrated base chemicals: acidchlorite process by Hydrochloric Acid (HCl 9%) and Sodium Chlorite (NaClO₂ 7,5%).

There is no storage of chlorine dioxide therefore there is no chlorine dioxide gas or concentrated solutions outside of the process application.

LOTUS EASY is designed so that the reaction to produce chlorine dioxide takes place in a reaction chamber. Multi function valves on injection points ensure security of the reaction chamber.

ADVANTAGES

- Reaction at controlled pressure
- High degree of stability of the chlorine dioxide solution
- No ClO₂ loss due to closed reaction chamber
- Diluted chemicals

PANEL

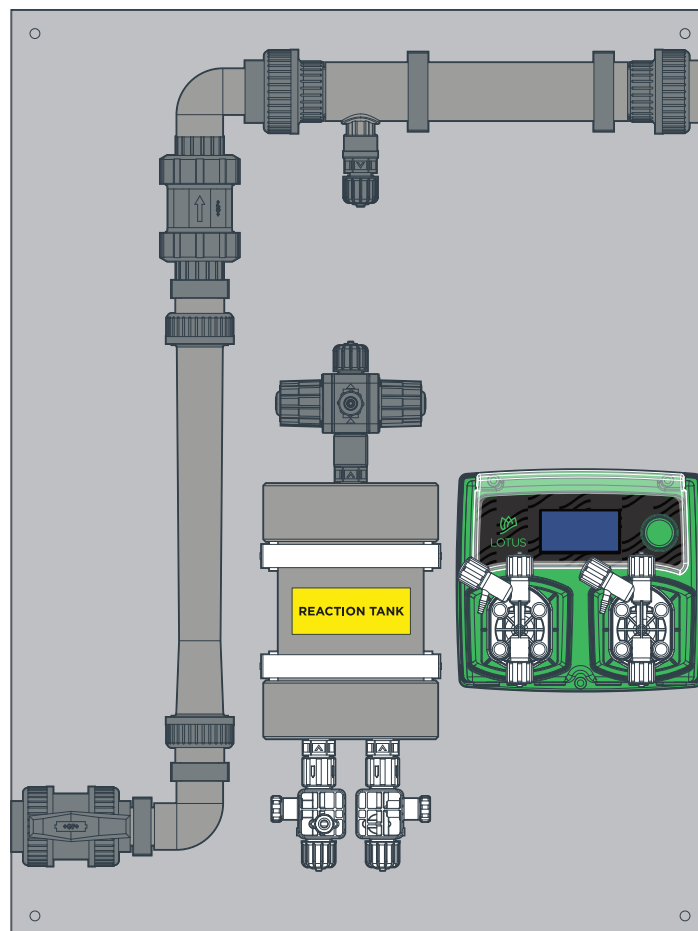

ALARMS

- ↪ sefl alarm
- ↪ bypass alarm
- ↪ acid/chlorine level alarm
- ↪ acid/chlorine sefl alarm

INPUTS

- ↪ mA input
- ↪ stand-by input
- ↪ acid/chlorine level input
- ↪ bypass input
- ↪ acid/chlorine sefl input
- ↪ water meter input

OUTPUTS

- ↪ alarm output



MODELS

- EASY 8 / EASY 20 / EASY 40 / EASY 80



ONLINE STATS



CUSTOMIZABLE



APP



REMOTE CONTROL

FUNCTIONS

- Instantaneous ClO₂ production
- ClO₂ dosing in proportional mode
- Level alarms
- Water meter input
- Stand-by input
- Real time production data
- Pumps and SEFL flow sensors monitoring
- Service due date
- By-pass flow detection
- mA (0-20mA) input

FEATURES

- ClO₂ concentration: 2 g/l
- Level alarms
- 2 flow sensors
- MFKT/V multifunction valve as pressure, safety, anti-syphon and bleed
- Static mixer
- PVC reaction chamber
- Working temperature: 0-45°C (32-113°F)
- 600 x 800 mm panel mounting
- By-pass diameter: DN 40

Overview table

Lotus Easy configuration performances

MODELS	MAX FLOW RATE ClO ₂	MAX CHEMICAL CONSUMPTION*	CONCENTRATION OF CHEMICALS	REACTOR	MAX PRESSURE (FEED WATER)	MAX WORKING PRESSURE***
EASY 8	8 g/h	0,2 l/h				8 bar
EASY 20	20 g/h	0,5 l/h	9% HCl	PVC	**	8 bar
EASY 40	40 g/h	1 l/h	7,5% NaClO ₂			8 bar
EASY 80	80 g/h	2 l/h				8 bar

* Max chemicals consumption value is referred to a single reagent, multiply by two to obtain the total consumption of liters/hour

** Depends on system pressure (max 8 bar)

*** For higher pressures use an external pump

POOLBRAVO

The swimming pool made smart

 **POOLBRAVO** BASIC | USB | ETH | GSM | WIFI | MODBUS



DIGITAL SERVICES

POOLBRAVO is a turnkey product available in a variety of configurations to manage the main measurement parameters involved in pool water treatment immediately and easily, optimizing accordingly the dosing and consumption of the chemicals needed to meet the chemical and physical requirements of the water. Chemical parameters that can be measured and adjusted include pH, chlorine, hydrogen peroxide, ozone and bromine.

COVER

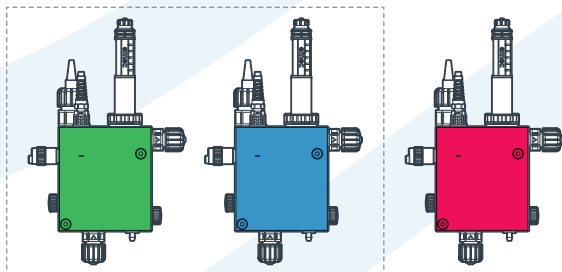

A **multi-color LED**, installed on the PEF probe holder and visible, through an aperture, signals system operating states or any alarms with different colored lights.

GREEN or **BLUE** (depends on version): indicates correct tuning of the device.

RED: indicates that the device is in a lock alarm state.



POOLBRAVO is an easy-to-use, high-precision all-in-one solution that eliminates the need for manual intervention on pool water and reduces chemical consumption. An elegant cover makes POOLBRAVO suitable for any installation context and, in addition to protecting against accidental leaks, at the same time preserves the cleanliness and integrity of its internal components.

COMPLETE CONTROL

The LD digital multiple-reading system, which is easy to use thanks to the LCD display and ENCODER knob that allow easy navigation through its configuration menus, and the wide choice of installable probes (allowing accurate measurement of hydrogen peroxide, oxygen, bromine,

chlorine, ozone, peracetic acid, and chlorine dioxide) ensure POOLBRAVO's complete control over pre-set measurement parameters and chemical dosing. EMEC V-series metering pumps complete the dosing system.

REMOTE CONTROL

POOLBRAVO can be controlled and set remotely via the web with any smartphone, PC or tablet, thanks to integration with the proprietary NIMBUS online system, so you have everything under control at any time.

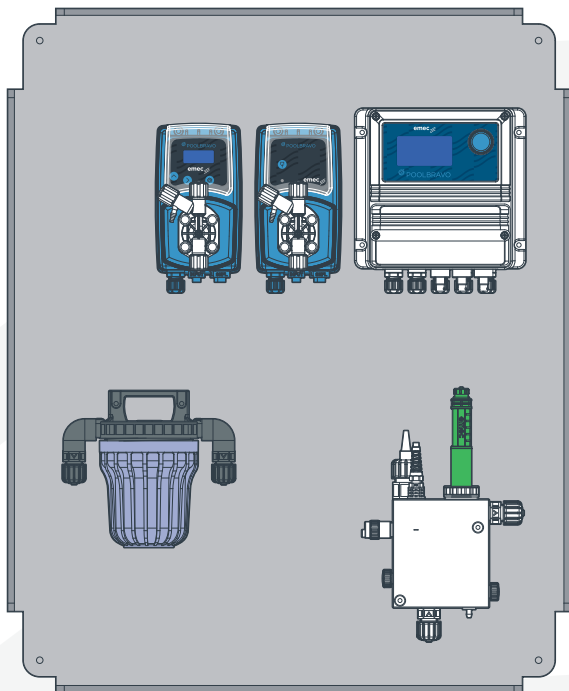

PANEL

- ACID PUMP
- CHLORINE PUMP

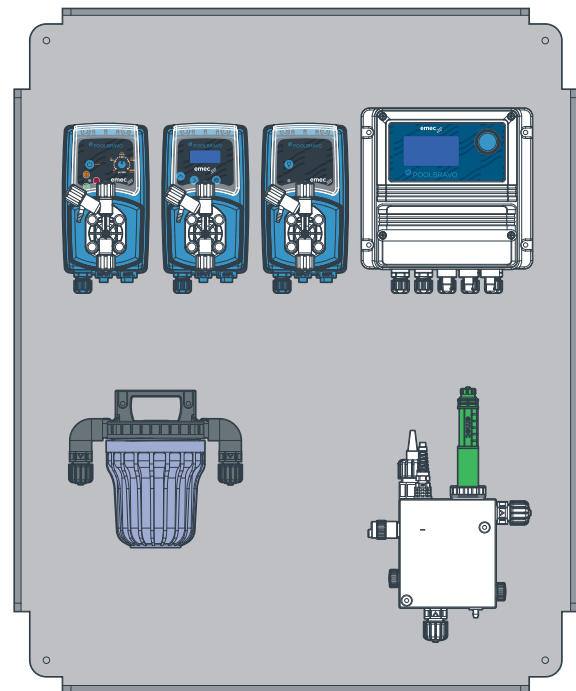

PANEL

- ACID PUMP
- CHLORINE PUMP
- ANTI-ALGAE PUMP / FLOCCULANT

ALARMS

- ➔ Main alarm

POWER SUPPLY

12 24	VDC
24	VAC
100-240	VAC

INPUTS

- ➔ Stand-by
- ➔ Flow
- ➔ pH level (+)
- ➔ pH level (-)
- ➔ Chlorine level
- ➔ pH probe
- ➔ Chlorine probe
- ➔ Temperature probe

OUTPUTS

- ➔ pulses proportional for pH
- ➔ pulses proportional for Chlorine
- ➔ Anti-alghe / Flocculante

Preconfigured Solutions for Pools, Spas and Water Treatment Systems

Multiparameter Control and Dosing System for Pools, Spas and Water Treatment

PANELS BASIC | USB | ETH | GSM | WIFI | MODBUS



READING PARAMETERS

- pH
- ORP
- FREE CHLORINE
- TOTAL CHLORINE
- COMBINED CHLORINE
- TEMPERATURE
- TEMPERATURE
- TURBIDITY
- PERACETIC ACID
- CHLORINE DIOXIDE
- PEROXIDE

GENERAL FEATURES

- Multiparameter control with WN, Velon, WD, LD and CENTURIO instruments
- Fragrance dosing
- Disinfection: bromine, ozone, flocculant, algaecide
- Dechlorination and filter backwash systems
- Remote control
- K, Prisma, T, V, WN and Velon pumps

PA-CEDB

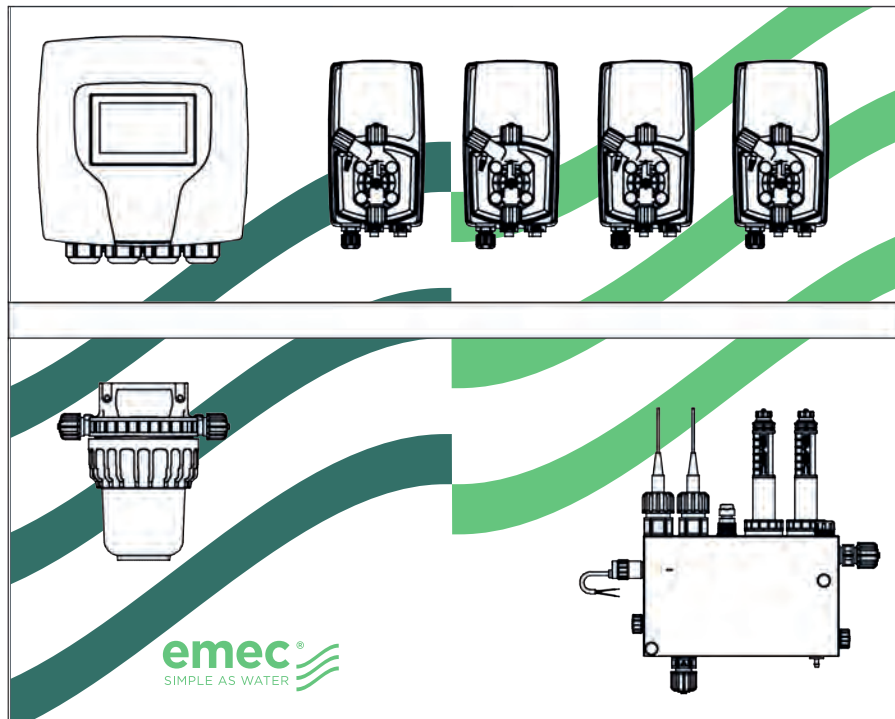

TOTAL CONTROL OVER PH, ORP, FREE CHLORINE, TOTAL CHLORINE, COMBINED CHLORINE AND TEMPERATURE FLOCCULANT AND ALGAECIDE DOSING

- CENTURIO multiparameter controller
- Acid dosing pump
- Chlorine dosing pump
- Flocculant dosing pump
- Algaecide dosing pump
- NFIL filter
- pH probe
- Redox (ORP) probe
- Temperature probe
- Free chlorine probe
- Total chlorine probe
- Probe holder

Pre-assembled panel, also available with custom color background

The images on these pages are for illustrative purposes only; for more information on possible configurations, contact the order department or your sales representative.



PA-WNPHRH

Pools & SPAS

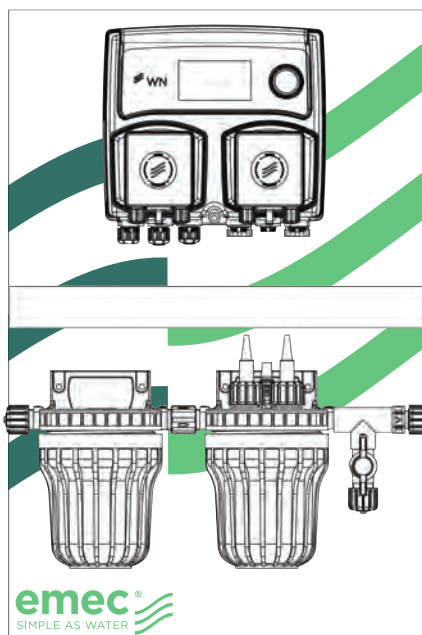

PROPORTIONAL CONTROL OF PH AND REDOX (ORP)

OUTPUT: RS485

- WNPHRH 0212 controller
- NFIL filter
- ERHS Redox (ORP) probe
- EPHS pH probe
- NPED4 electrode holder

Pre-assembled panel, also available with custom color background

PA-LDSCL

Water treatment

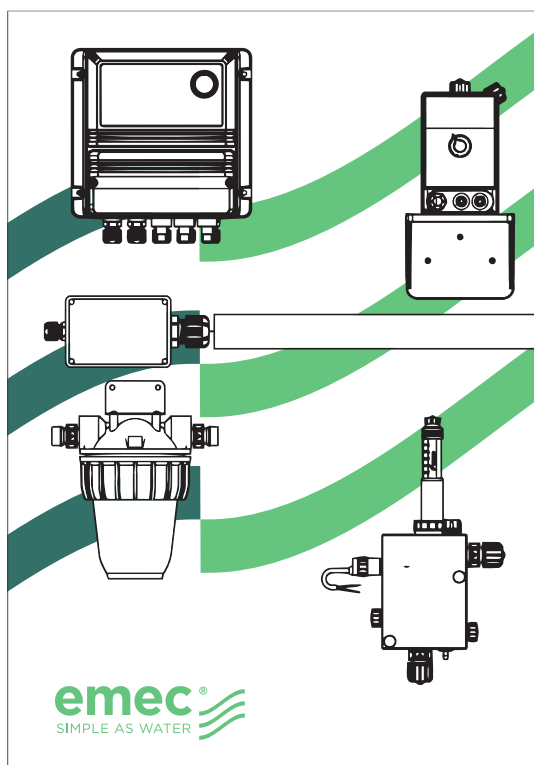

PROPORTIONAL CHLORINE CONTROL

- LDPHCL | LDSCL PLUS controller
- Chlorine dosing pump
- NFIL filter

- Temperature probe
- Chlorine probe
- Flow-through electrode holder

Pre-assembled panel, also available with custom color background

The images on these pages are for illustrative purposes only; for more information on possible configurations, contact the order department or your sales representative.

Preconfigured solutions for Cooling Towers

Multi-parameter dosing and control system for Cooling Towers

PANELS BASIC | USB | ETH | GSM | WIFI | MODBUS



READING PARAMETERS

- CONDUCTIVITY
- INDUCTIVE CONDUCTIVITY
- pH
- ORP
- CHLORINE (TOTAL, FREE AND COMBINED)
- TEMPERATURE
- HYDROGEN PEROXYDE
- BROMINE
- OZONE
- CHLORINE DIOXIDE
- PARACETIC ACID
- TRACERS
- CORROSION
- TURBIDITY
- mA INPUT

GENERAL FEATURES

- Multiparameter control with LD, MTOWER and CENTURIO TOWER controllers
- Designed for industrial water treatment
- Conductivity control
- Automatic purging
- Remote control

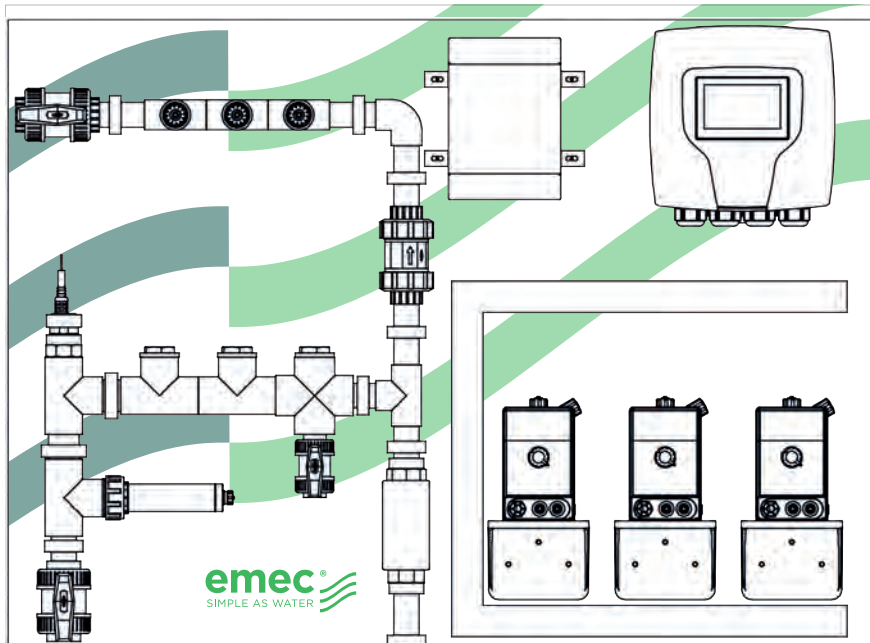

FEATURES

Panel with CENTURIO/MTOWER controller, featuring three measurements (CD, pH and Redox), measurement and dosing of make-up and bleed flow, complete with piping for measurement, 1", 1/2" bleed line and three injection points, equipped with 2 dosing pumps (expandable).

Available in 2 versions: Capacitive CD and Inductive CD.

Optional: also available with custom full-color background

CONDUCTIVITY

controller | CENTURIO/MTOWER-CD-PH-RH

p. holder | PIPING with EV and injection points

probes | ECDCCPT
EPHS
ERHS

pumps | Up to 2x KMF1504 (with bracket)

INDUCTIVE CONDUCTIVITY

controller | CENTURIO/MTOWER-CD-PH-RH

p. holder | PIPING with EV and injection points

probes | ECDIND
EPHS
ERHS

pumps | Up to 2x KMF1504 (with bracket)

The images on these pages are for illustrative purposes only; for more information on possible configurations, contact the order department or your sales representative.



PA - TURBIDITY MEASUREMENT WITH CLEANING KIT

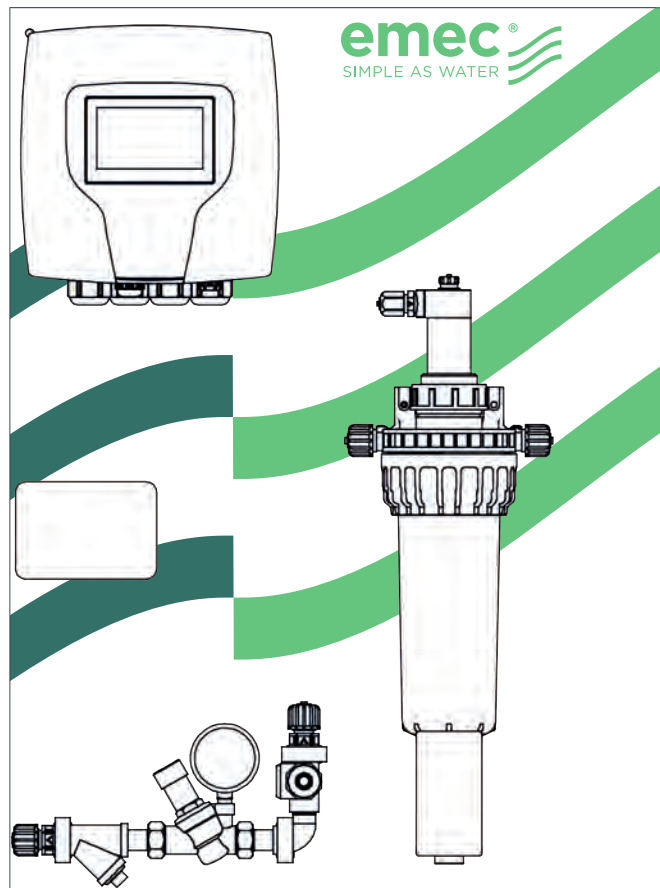

FEATURES

PANEL WITH CENTURIO CONTROLLER FOR TURBIDITY CONTROL, EQUIPPED WITH A CLEANING KIT FOR THE TURBIDITY PROBE.

- Centurio controller (alternatively LD controller)
- Probe holder for turbidity probe, model NPED-E2-EV
- Turbidity probe, model ETORB2N
- Cleaning kit for turbidity probe, model ETORB2N

Optionale: Also available with LD controller
Also available with custom full-color background

Preconfigured solutions

SKID multi-parameter dosing and control system

SKID BASIC | USB | ETH | GSM | WIFI | MODBUS



The Skid System is a modular and autonomous system, built with specific characteristics, with the aim of assisting the operation of more complex industrial systems.



DIGITAL SERVICES

The advantage of this SKID comes from the fact that it is assembled and tested before arriving at the site of use. Integration with the main plant is therefore very rapid, and this allows interruptions to the production cycle to be minimised. An essential element of each Skid is the platform on which it is mounted. In addition to providing a solid and specific internal support, the platform must allow for easy and safe transport of the Skid after it has been assembled, and facilitate access by those responsible for its operation.

For this reason, each platform must be designed and built specifically for each individual Skid system.

READING PARAMETERS

CONDUCTIVITY

INDUCTIVE CONDUCTIVITY

pH ORP

CHLORINE (TOTAL, FREE AND COMBINED)

TEMPERATURE

HYDROGEN PEROXYDE BROMINE

OZONE CHLORINE DIOXIDE

PARACETIC ACID TRACERS

CORROSION TURBIDITY mA INPUT

SKID SYSTEM MEDIUM

The MEDIUM size model designed with two **AMS MF** or **KMS MF** or **PRISMA MF** allows the complete treatment of products for medium-size industrial plants.

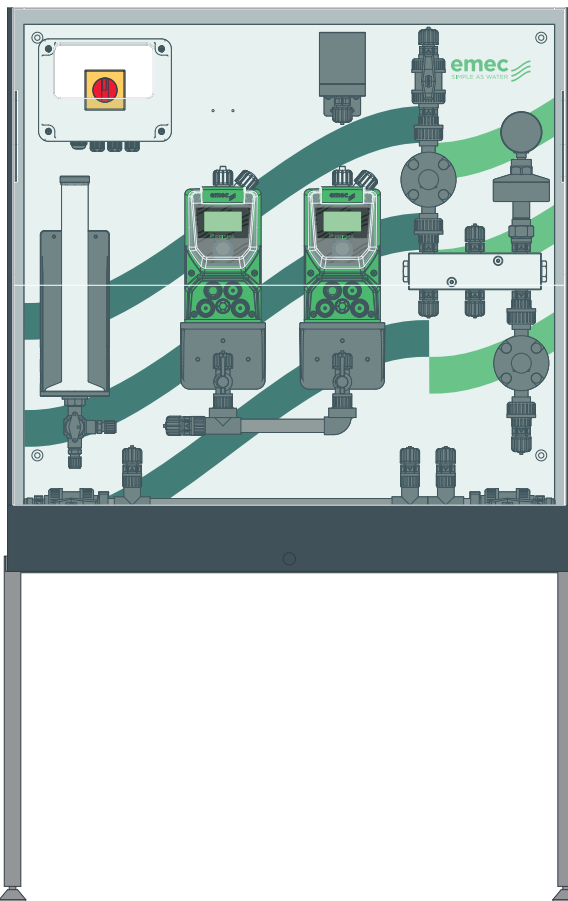

OVERVIEW

- PVC panel mounted in a PVC frame, 1 injection point, 2 pumps
- Always included: PVC valves and piping, bracket, safety valve, manifold, electrical box with switch
- DN 15 PN 16 with female thread for inlet and outlet
- Pump Head: PVDF or PP (no LPV)
- O-rings: VITON, DUTRAL, WAX

BASIC CONFIGURATION

- Structure + Panel (800 x 800 mm)
- No. 1 pump: (K CL PLUS, KMS MF, AMS MF, AMS CL PLUS, PRISMA)
- No. 1 pump: (K CL PLUS, KMS MF, AMS MF, AMS CL PLUS, PRISMA)

ACCESSORIES

- SOIM 3
- Calibration Cylinder
- Manometer
- Cover in PMMA
- Legs in steel
- Personalization: (the graphic of the panel)

The images on these pages are for illustrative purposes only; for more information on possible configurations, contact the order department or your sales representative.



CUSTOMIZE YOUR SKID SYSTEM

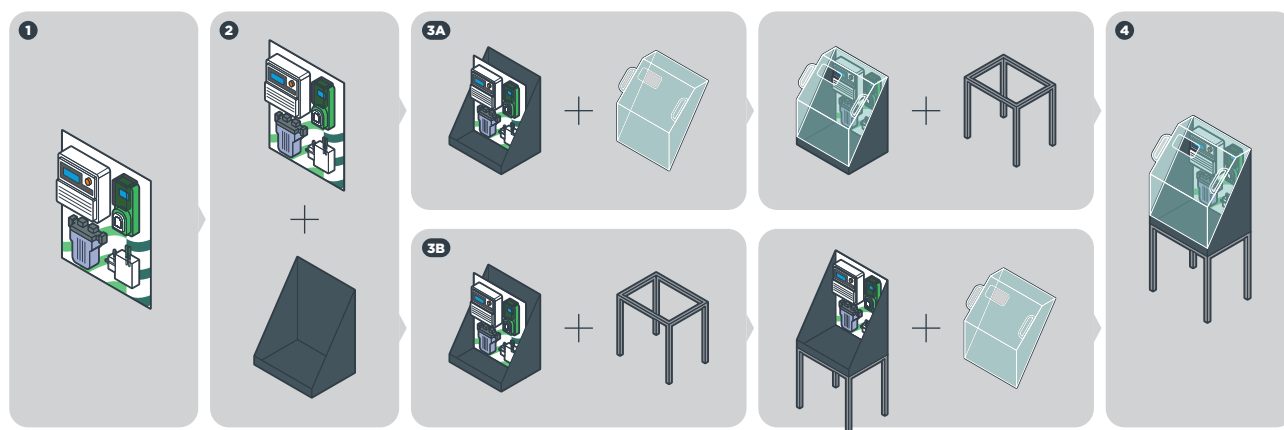

SKID SYSTEM SMALL

The SMALL size model designed with a **PRISMA MF** (Multifunction dosing stepper motor pump) allows the complete treatment of products for small-size industrial plants.

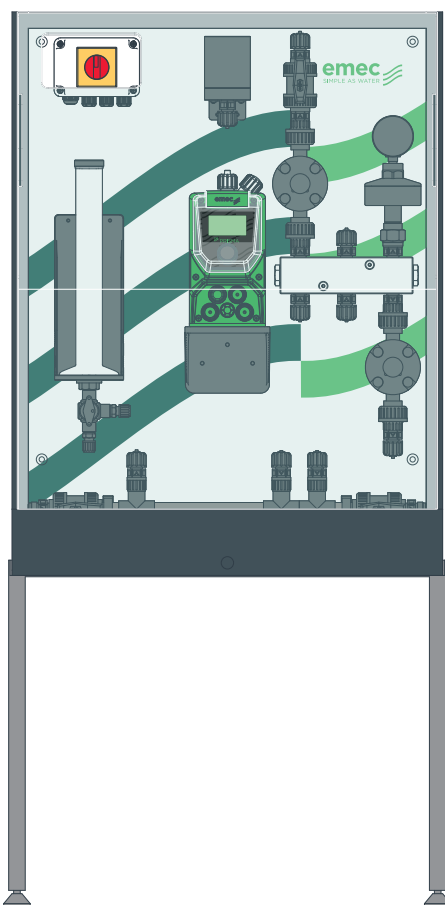

OVERVIEW

- PVC panel mounted in a PVC frame, 1 injection point, 1 pump
- Always included: PVC valves and piping, bracket, safety valve, manifold, electrical box with switch
- DN 15 PN 16 with female thread for inlet and outlet
- Pump Head: PVDF or PP (no LPV)
- O-rings: VITON, DUTRAL, WAX

BASIC CONFIGURATION

- Structure + Panel (600 x 800 mm)
- No. 1 pump: (K CL PLUS, KMS MF, AMS MF, AMS CL PLUS, PRISMA)

ACCESSORIES

- SOIM 3
- Calibration Cylinder
- Manometer
- Cover in PMMA
- Legs in steel
- Personalization: (the graphic of the panel)

The images on these pages are for illustrative purposes only; for more information on possible configurations, contact the order department or your sales representative.

ADVANCED REMOTE MONITORING AND CONTROL SYSTEM

NIMBUS

Online platform for remote control

NIMBUS is an online platform that enables remote monitoring and control of all parameters of compatible EMEC products, allowing interactive management of probes, instrument inputs, product levels, temperature and setpoints.

HOW DOES NIMBUS WORK?

All EMEC instruments equipped with an encoder or touchscreen and an Ethernet or 3G/4G connection are immediately connected and ready for use.

In addition to remote interaction, NIMBUS allows you to receive email notifications regarding alarms and the status of your instruments, based on various configuration options.



ADVANTAGES

- Reduced on-site inspections and maintenance interventions
- Real-time status of network devices (probes, outputs, alarms and setpoints)
- Customisable reports including data from all plant instruments
- Charts, tables and activity logs downloadable to a PC (CSV format)
- Activity scheduling with automatic reminder notifications

COMPATIBLE SYSTEMS

- PRISMA
- CENTURIO PRO / POOL / TOWER
- MTOWER
- WD
- LD / LDS
- WN
- WT
- VELON
- LD OSIN PLUS
- LOTUS



KEY FEATURES

Nimbus has been developed to deliver a complete, intuitive and secure user experience: from interactive plant status visualisation to geolocation, from remote configuration to maintenance planning.

Thanks to advanced reporting tools, role-based access management, and the highest standards of security and data protection, Nimbus supports companies and teams in efficiently monitoring their infrastructure, streamlining daily operations and enhancing overall operational control.



**INTUITIVE AND
CUSTOMIZABLE
DASHBOARD**



**INTERACTIVE MAP
WITH REAL-TIME
MONITORING OF
SYSTEMS AND
DEVICES**



**BUILT-IN
GEOLOCATION
FOR ALL YOUR
INSTALLATIONS
AND DEVICES**



**GUIDED DEVICE
REGISTRATION**



**REMOTE SETUP AND
CONTROL, ANYTIME,
ANYWHERE**



**SMART TEAM
MANAGEMENT WITH
PROFILED ACCESS
LEVELS**



**INTEGRATED
CALENDAR TO PLAN
TASKS AND
MAINTENANCE**



**DETAILS,
CUSTOMIZABLE
REPORTS AT YOUR
FINGERTIPS**



**MULTILINGUAL
PLATFORM**



**SECURE CONNECTION
WITH STATE-OF-THE-
ART ENCRYPTION**



**DATA MANAGEMENT
IN COMPLIANCE WITH
THE HIGHEST
SECURITY AND
PRIVACY STANDARDS**



Fast, simple and intuitive
YOUR SMART ASSISTANT

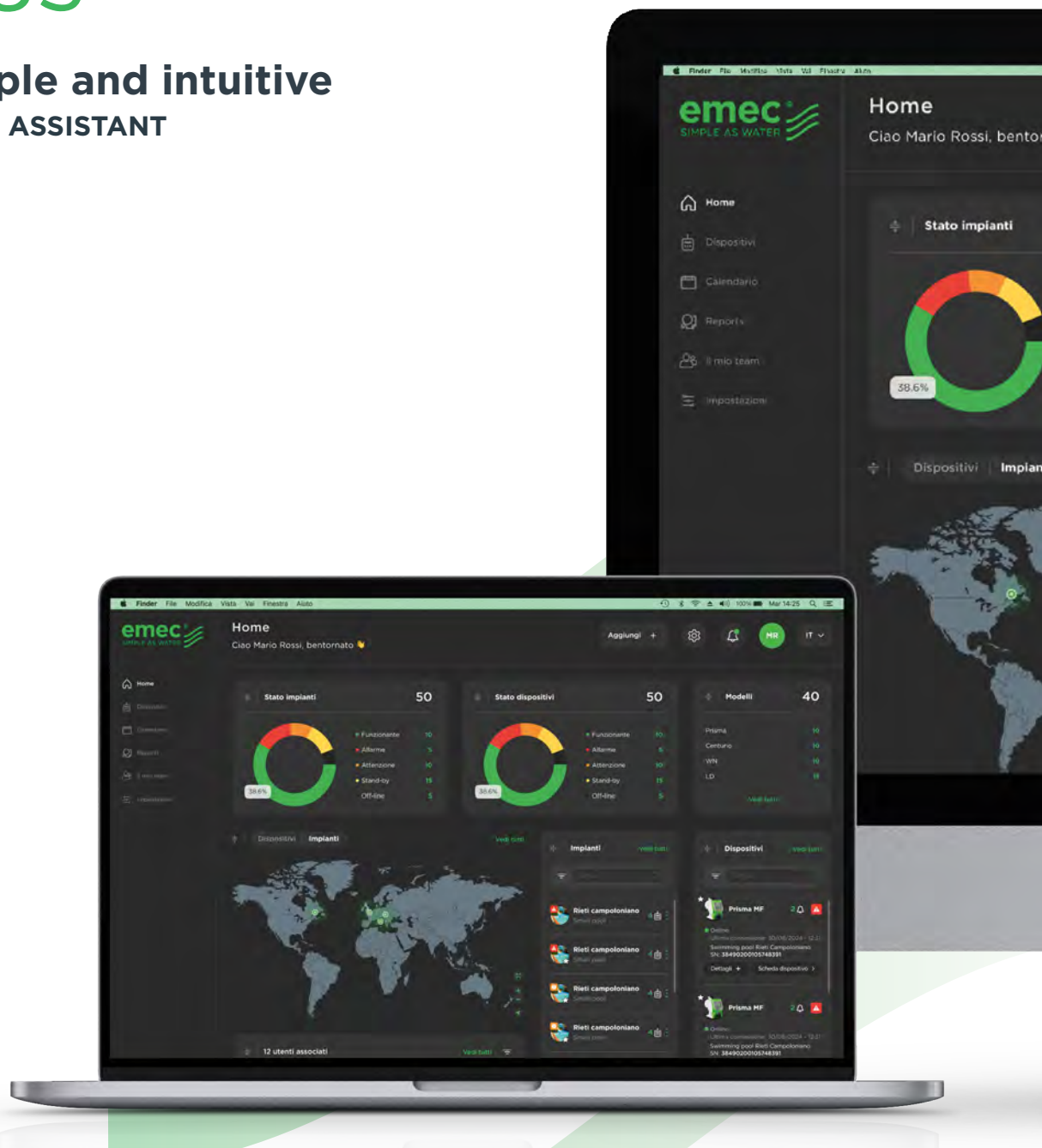

**A MULTILINGUAL WEB
PLATFORM**

The user interface is available in 34 languages

MULTIPLE ACCESS LEVELS

Multiple users can be added to the system, with different access levels configurable for each plant.

**STATUS NOTIFICATIONS
PUSH**

Set up push notifications on the status of your installations.



EVERYTHING UNDER CONTROL

Real-time display of all your plant parameters and monitoring of the status of all probes

REAL-TIME MANAGEMENT

Real-time management and configuration of all your plant parameters

REAL-TIME CHARTS

Charts of all your plant parameters, based on both real-time data and stored data



Hi, John Doe

MASTER Account

Device Configuration Wizard

Add New Profile

Last Notifications



Alarm

Level Alarm

45 min ago



Warning

Level Warning

45 min ago

Devices

All

Normal

Alert

Warning



Prisma MF

Swimming pool Rieti Campoliano/Small pool
SN: 38490200105748391

Working mode: --

Working rate: --
Slow mode: --



Home



Notification



Devices



Documents



Profile

My Emec

The app by EMEC

All your systems in your hand



Download on the
App Store



GET IT ON
Google Play

9:41

< Back



Prisma MF

Swimming pool Rieti
Campoliano/Small pool

SN: 38490200105748391

Turn off

LABEL

Label Name

STATUS

Working Mode

Working Rate

Slow mode

WORKING MODE

Constant



Home



Notification



Devices



Documents

Pro

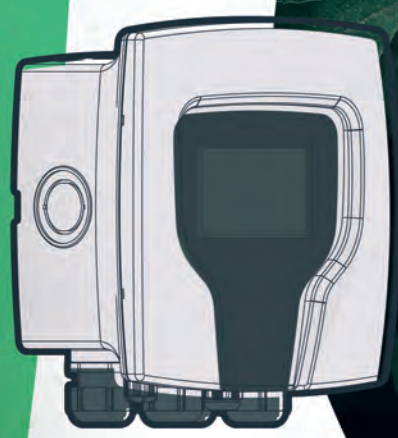

www.emecpumps.com
follow us



Emec Tutorial

Find our installation videos and much more on Youhose

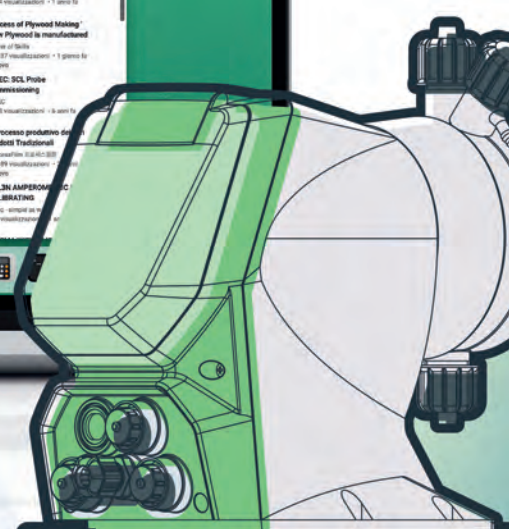



cód. 20201400



EMEC S.r.l. Via Donatori di Sangue, 1 - 02100 Rieti - Italia

T. +39 0746 2284 1 F. +39 0746 2284 2

info@emec.it - www.emecpumps.com